



# Development of an Automatic Load Moment Control System for a Floating Dock

**Manuel Melo Sanchez**

**Master Thesis**

presented in partial fulfilment  
of the requirements for the double degree:  
“Advanced Master in Naval Architecture” conferred by University of Liege  
“Master of Sciences in Applied Mechanics, specialization in Hydrodynamics,  
Energetics and Propulsion” conferred by Ecole Centrale de Nantes  
developed at University of Rostock  
in the framework of the

**”Emship  
Erasmus Mundus Master Course  
in “Integrated Advanced Ship Design”**

Ref. 159652-1-2009-1-BE-ERA MUNDUS-EMMC

Supervisors: Prof. Robert Bronsart, University of Rostock  
Dipl.Ing. Stefan Winkler, Hoppe Marine

Reviewer: Prof. Dario Boote, University of Genoa

Rostock, January 15, 2013



## List of Figures

1	Basic floating dock & Submersible floating dock . . . . .	8
2	Example of a flowchart . . . . .	12
3	Trapezoid rule approximation . . . . .	13
4	Equivalent distributed force . . . . .	15
5	Floating body statics sketch . . . . .	16
6	Sketch of a heeled vessel . . . . .	16
7	GZ-curve . . . . .	17
8	Two shore beams will keep the dock at $0^\circ$ . . . . .	19
9	3D view of floating dock . . . . .	19
10	Sketch of the dock . . . . .	20
11	Distribution of trolleys . . . . .	24
12	Trolley specifications . . . . .	25
13	Sketch used for calculations . . . . .	26
14	Volumetric flow at different water levels . . . . .	27
15	Actual tank configuration . . . . .	28
16	Proposed tank configuration . . . . .	28
17	Tanks centre of gravity . . . . .	28
18	Moment meter X meter . . . . .	32
19	Designated trolley speed by designer . . . . .	34
20	Ballast system maximum at different capacities . . . . .	35
21	Comparison of trolley speed profiles . . . . .	36
22	Lever arm difference between the transfer and righting moment . . . . .	37
23	Moment comparison with control over draft and trim . . . . .	39
24	Trim, Draft and Total change during transfer sequences . . . . .	39
25	title . . . . .	40
26	Tank water flow during loading sequences . . . . .	42
27	General flowchart of simulation . . . . .	43
28	Free body diagram for limit_tm . . . . .	44
29	Warning message if capacity was exceed . . . . .	45
30	Cascade positioning from left to right . . . . .	47
31	Cascade positioning from right to left . . . . .	47
32	Question to erase all previous data . . . . .	52
33	User interface for data input . . . . .	53
34	Warning for incorrect input . . . . .	54
35	Transfer moment plotted by algorithm . . . . .	56

## List of Tables

1	Common Flow Chart Symbolism . . . . .	11
2	Dock specifications . . . . .	21
3	Operational Wind Pressure . . . . .	21
4	Freeboard operational limits . . . . .	21
5	Constant parameters . . . . .	23
6	Programmable parameter . . . . .	23
7	Vessel Blocking System Specifications . . . . .	25
8	Data utilized for calculations . . . . .	26
9	Volumetric flow at different water levels . . . . .	27
10	Tank maximum capacity . . . . .	29
11	Monitor sensor system specifications . . . . .	29
12	Vessel specifications used for transfer analysis . . . . .	31
13	Left → initial filling state, Right → final filling state . . . . .	38
14	Final tank levels . . . . .	40
15	Tank filling states during loading sequences . . . . .	41
16	tab_initial.tab file example . . . . .	52
17	Part of the <i>tank_combi.tab</i> document . . . . .	57
18	Pre-loading specifications . . . . .	63

# Contents

<b>List of Figures</b>	<b>2</b>
<b>List of Tables</b>	<b>3</b>
<b>1 INTRODUCTION</b>	<b>8</b>
1.1 State of the art . . . . .	9
1.2 Scope of Work . . . . .	10
<b>2 LITERATURE SURVEY</b>	<b>11</b>
2.1 Algorithms . . . . .	11
2.2 Trapezoid Rule . . . . .	12
2.3 Equilibrium Equations . . . . .	13
2.3.1 Equivalent Distributed Forces . . . . .	14
2.4 Stability . . . . .	16
<b>3 PROJECT DESCRIPTION</b>	<b>19</b>
3.1 The dock . . . . .	19
3.1.1 Important Design and Operational Specifications . . . . .	21
3.2 Transfer Master System Specifications . . . . .	22
3.2.1 Simulation Modelling . . . . .	22
3.2.2 Automatic Control System . . . . .	24
3.2.3 Vessel Blocking Control . . . . .	24
3.2.4 Dock Ballast Control . . . . .	25
3.2.5 Monitor Sensors . . . . .	29
3.3 Transfer Operation Description . . . . .	30
<b>4 STATIC ANALYSIS</b>	<b>31</b>
4.1 Meter X Meter . . . . .	31
4.2 Righting Moment vs Transfer Moment . . . . .	32
4.3 Moment Calculation with Trim and Draft Control . . . . .	37
<b>5 ALGORITHM</b>	<b>43</b>
5.1 Trolley Placement . . . . .	43
5.2 Ballast tank planning . . . . .	51
<b>6 CONCLUSION</b>	<b>60</b>
<b>7 APPENDIX</b>	<b>62</b>
<b>8 Bibliography</b>	<b>75</b>

**Declaration of Authorship**

*I declare that this thesis and the work presented in it are my own and has been generated by me as the result of my own original research.*

*Where I have consulted the published work of others, this is always clearly attributed.*

*Where I have quoted from the work of others, the source is always given. With the exception of such quotations, this thesis is entirely my own work.*

*I have acknowledged all main sources of help.*

*Where the thesis is based on work done by myself jointly with others, I have made clear exactly what was done by others and what I have contributed myself.*

*This thesis contains no material that has been submitted previously, in whole or in part, for the award of any other academic degree or diploma.*

*I cede copyright of the thesis in favour of the University of.....*

Date:

Signature:

## ABSTRACT

A floating dock will be built, the manufacturer and owner is **Baku Shipyard**. **POSS** is the dock designer. **TTS** is installing a trolley transfer system so that vessels can be transferred into and out of the shipyard. **Hoppe Marine** is in charge of the dock control and monitoring during the transfer operation. The goal of the project is to create an automatic control system which will plan, execute and monitor constantly the following:

- Launching
- Docking
- Transfer Shore/Dock
- Transfer Dock/Shore

Detailed static analysis has already been carried out to evaluate the transfer system operation. Using a maximum ship displacement of 5000 t, the moment curve and the loading sequence behaviour per meter advanced were determined. Preliminary results show that the variables controlling the process are the space between trestles, the load per trestle, the pump volumetric flow or RPM and the trolley speed. Additionally, analysis has proven that the ballast system compensating the moment generated by the transferring ship cannot follow the trolleys at nominal speed for the first 40-50 meters. As a consequence, the trolley speed cannot be a constant value and must be reduced considerably at the beginning of the transfer. As many existing floating docks, gravity based filling was proposed, but the implementation of reversible pumps was preferred due to the low flexibility and time response of gravity based filling.

The aim of this thesis, is a detailed description of the Dock Operation Control System and a Matlab simulation of the transfer from shore to dock. The concept of simulation is that it will be able to determine all the variables controlling the process by itself. Creating an algorithm defining the simulation requires constant consideration of factors such as which data is necessary, which data is optional and which restrictions to arise during the whole process. The simulation is intended to be used as a basis for the remaining transfer/docking processes and to generate on-board simulation software.

## NOMENCLATURE

<b>LOA</b>	Length over all	<i>m</i>
<b>GM</b>	2cmMetacentric height	<i>m</i>
<b>MTC</b>	2cmMoment to change trim 1 cm	<i>(t.m)/cm</i>
<b>MHD</b>	2cmMoment to change heel 1 degree	<i>(t.m)/degrees</i>
<b>LCG</b>	Longitudinal Centre of Gravity	<i>m</i>
<b>TCG</b>	Transversal Centre of Gravity	<i>m</i>
<b>G</b>	Centre of Gravity	<i>m</i>
<b>B</b>	Centre of Buoyancy	<i>m</i>
<b>K</b>	Keel position	<i>m</i>
<b>M</b>	Metacentre	<i>m</i>
<b>GZ</b>	Righting arm	<i>m</i>
<b>F</b>	Force	<i>N</i>
<b>C</b>	Fluid speed	<i>m/s</i>
<b>V</b>	Volume	<i>m<sup>3</sup></i>
<b>A</b>	Area	<i>m<sup>2</sup></i>
$\rho$	Density	<i>t/m<sup>3</sup></i>
$\mu$	Form factor for vents	-

# 1 INTRODUCTION

Floating docks are an important tool which have long been part of the maritime world. There are different types of floating docks with different purposes. The most common and simple one is the one seen often at lakes, rivers and marinas. It consists of a pontoon that can be defined as a rectangular flat-bottom floating structure with a wide clear space without obstructions. This kind of floating dock is mainly employed to embark and disembark people from boats and vessels. Other more complex and bigger floating docks are for example, the ones used to load crude oil into vessels like the Alyeska port at Valdez, Alaska.

These types of floating docks can rise and fall with the tide but they operation is strictly above the water level. The type of floating dock referred at this document, is the submersible floating dock. This kind of floating dock consists also of a pontoon with enough area to place a vessel over it. Additionally, it has two side walls to increase stability of the pontoon. Its shape can be compared to a U-shape container.



Figure 1: Basic floating dock & Submersible floating dock

Available: [http://www.crandalldrydock.com/Halifax\\_floating.html](http://www.crandalldrydock.com/Halifax_floating.html)

Available: <http://www.skyscrapercity.com/showthread.php?t=813054&page=314>

Four main operations can be distinguished in floating docks, each one has an unique purpose. All operations work by admitting water to ballast tank compartments or removing it. Their generalized course of action is:

- **Launching**

The vessel is on the floating dock. The vessel's hydrostatic data is used to plan the operation. The ballast tanks are flooded by gravity base filling or pumping until planned draught is reached. The vessel is taken out of the dock with the aid of tugs.

- **Docking**

The vessel is floating close to dock. The vessel's hydrostatic data is used to plan the operation and static data is used for dock planning. The dock is submerged until there is enough clearance between the hull and the dock. The vessel is pushed into the dock with the aid of tugs. The ballast tank's water is pumped out until the dock emerges to the planned draught, at this point transfer to the shore is possible.



- Transfer Shore/Dock

The vessel is on the shore. Water must be admitted and removed accordingly to compensate the momentum generated by the incoming vessel. Once the vessel is positioned correctly, launching operations can proceed.

- Transfer Dock/Shore

The vessels is on the dock. Water must be admitted and removed accordingly to compensate the momentum generated by the displacement of the vessel. The operation finishes once the vessel is completely on the shore.

The capacity in tons that the floating dock can work with depends on the each operation being performed. Launching and docking have the same capacity limit which is defined by the dock's structural strength. Nonetheless, transfer operations are limited by the ballast system's capacity to react and compensate the moment, therefore the working capacity tends to be smaller. A floating dock with a capacity to launch/dock a vessel of 16,000 *t* can manage a transfer operation of around 5000 *t*.

Floating dock operations are planned and controlled by dock masters. Based on the vessel's shape, structural arrangement, hull shape, light weight distribution and the vessel's heel and trim, he must correctly set the block arrangement or docking plan that will support the vessel. The dock master must actively receive all possible feedback from the dock to plan every phase during dock operations. Consequently, dock operations take hours to be performed. Despite its complexities, floating docks are extensively used for repair and shipbuilding works in actuality. The fact that they can be moved to where they are being required and they can take more than one ship at a time becomes quite advantageous for most shipyards.

*Baku Shipyard* designed and will build a floating dock to increase its production capacity. The company *TTS* presented a trolley transfer system and together with *Hoppe Marine* a Dock Operation Control System is being proposed and an algorithm to simulate the transfer from shore to dock is being presented. The simulation is intended to be used as a basis for the remaining transfer/docking processes and to generate on-board simulation software.

## 1.1 State of the art

To perform such an extensive monitoring and control, a combination of sensors, actuators and control devices must be implemented. Many companies have develop technology that would even permit a dock master to monitor and control the dock even if he is present at another continent.

API Marine International is a Danish company which is specialized in measurement technology for cargo systems. They have developed a floating dock monitoring and control system known as TSS/Docking. The system has some innovative features like temperature monitoring of "dry" compartments, positioning of the vessel along the dock through lasers and it facilitates dock planning.

Another similar system was developed by Shangai Rongde Engineering Equipment CO. The product of this Chinese company is a center control desk which is composed of several subsys-

tems which control remotely and automatically the floating dock operations. Both systems include the following similar features:

- Monitoring
  - Level in Ballast tanks
  - Draft
  - Temperature and water presence in “dry” compartments.
  - Deflection
- Remote control
  - Vales, Shutters.
  - Pumps
- Warning if operation limit is reached

## 1.2 Scope of Work

This master thesis has two aims. First, it intends to analyse statically the response of the floating dock designed by Baku Shipyard when submitted to a moment generated by a transferring vessel. The objective is to identify key variables, restrictions and detect factors that could lead the ballast tank system to a better performance. The basic theory of stability of floating bodies and equilibrium of forces is required.

Secondly, the concept of an algorithm to automatize the transfer from the shore to the dock in order to create a Matlab based simulation. Matlab is an integrated environment for scientific computing and visualization. It is written in C language and is distributed by The MathWorks (Quarteroni and Saleri 10). The simulation’s objective is to determine the dock planning to sustain the vessel and define a ballast tank phase sequence that will nullify the moment generated by the transferring vessel. The simulation results will be compared to the ones obtained at the first stage of this thesis.

## 2 LITERATURE SURVEY

### 2.1 Algorithms

In general a problem is solved on the computer by an algorithm, which is best defined by Quateroni and Saleri (2003) as a precise directive in the form of a finite text specifying the execution of a finite series of elementary operations. These operations include arithmetic computation combined with logical manipulations to reach a conclusion or obtain an answer to a problem.

In his book, Chaudhuri (2005) mentions that in algorithms the law of *law of equifinality* is present in algorithms. This law states that one can obtain the same result in different manners. Hence, an algorithm can not be evaluated by the number of processes it contains or the way the algorithm has been written. This kind of criteria is used to evaluate the time needed to access the computer memory which becomes the elapsed time between the input and output phases.

To evaluate an algorithm, the methodology followed for its development must be understood. Although the same problem can be solved using methods, there is one that will be optimal. This optimal solution can only be chosen by comprehending the problem and the objectives involved in it.

The best tool to develop algorithms is a flow chart. Flow charts are graphic representations of an algorithm and they contain all steps followed by the algorithm. Their use is quite advantageous because they facilitate error detection at an early stage of the development and can be read easily and fast, even by a person who is not familiarized with the problem.

They are drawn from top to bottom or from left to right and have standard symbols which must be implemented correctly otherwise the program can be misread. The flow chart symbolism is presented in Table 1 and an example is shown in Figure 2.







Symbol	Description
	<b>Terminal.</b> - Defines the start and the end of a flow chart.
	<b>Process.</b> - Describes the process that must be executed.
	<b>Decision.</b> - Contains close-end questions which commonly are Yes-No questions. Each answer leads to a different course of action or process.
	<b>Input.</b> - Shows any input required or output given by the algorithm.
	<b>Input document.</b> - Declares any document or file needed as input to execute a process.
	<b>Sub-process.</b> - Makes reference to another algorithm or group of processes with out given detail on it.
	<b>Comment.</b> - Utilized to give comments by the algorithm creator to give additional information that he considers relevant.

Table 1: Common Flow Chart Symbolism

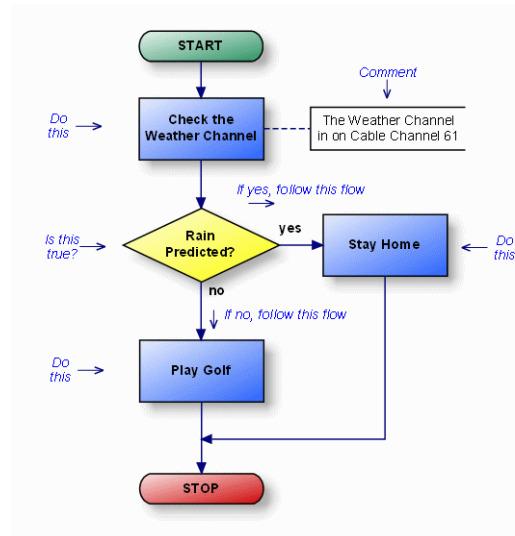

Figure 2: Example of a flowchart

Available at: <http://www.pacestar.com/edge/sample.htm>

From an algorithm a simulation can be created. Simulations are based on mathematical representations of events and objects of the “real world”. A loss of accuracy in simulations is always present because there are features that can not be included in mathematical models or are neglected to simplify modelling. Likewise, the completeness of the input data given by the user influences the accuracy greatly.

Simulations are used extensively to preform tests since factors such as human safety, elevated operation costs, scale and set up complexity are not taken into account.

The best simulation does not necessarily means an elaborated graphic representation. Depending on the mathematical model, simulations can be represented in 2-D or 3-D. The developer must determine the most suitable one to represent the results obtained.

## 2.2 Trapezoid Rule

The trapezoid method is a method to approximate the area under a curve or the value of an integral in a defined interval. The area of a trapezoid can be defined as a rectangle and a triangle combined or subtracted. Using as reference the first trapezoid from left to right on Figure 3, the area of a trapezoid is defined as:

$$Area = (\Delta x \times y_0) + \frac{(\Delta x(y_0 - y_1))}{2} \Rightarrow Area = \frac{\Delta x}{2}(y_0 + y_1) \quad (1)$$

To obtain the area under the curve all trapezoids on Figure 3 are added together and the equation becomes:

$$\int_a^b f(x)dx = \frac{\Delta x}{2}(y_0 + y_1) + \frac{\Delta x}{2}(y_1 + y_2) + \frac{\Delta x}{2}(y_2 + y_3) + \dots + \frac{\Delta x}{2}(y_{n-1} + y_n) \quad (2)$$

Simplifying, the extended trapezoidal rule is obtained:

$$\int_a^b f(x)dx = \Delta x \left[ \frac{y_0}{2} + y_1 + y_2 + y_3 + \dots + y_{n-1} + \frac{y_n}{2} \right] \quad (3)$$

To employ the trapezoidal rule correctly,  $\Delta x$  needs to be a constant value and the function or curve approximated must be continuous. Being an approximation, the trapezoidal rule has an error margin which is defined by the curvature of the function. It is assumed that ship lightweight distributions have low curvature values and rarely present sudden changes in sign. Thus, the error will be neglected for all calculations performed in the algorithm. The complete extended trapezoidal rule is shown below:

$$\int_a^b f(x)dx = \Delta x \left[ \frac{y_0}{2} + y_1 + y_2 + y_3 + \dots + y_{n-1} + \frac{y_n}{2} \right] - \frac{(\Delta x)^3 n}{12} f''(\xi) \quad (4)$$

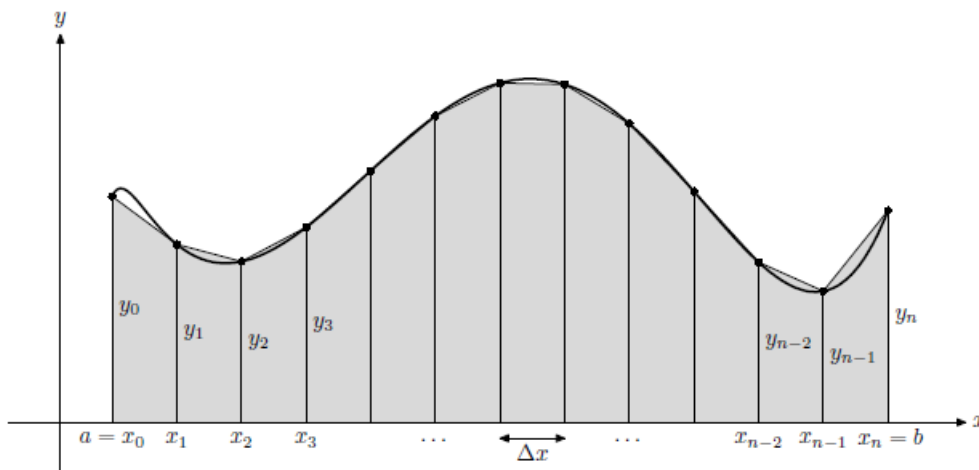

Figure 3: Trapezoid rule approximation

Available:

[http://pages.pacificcoast.net/~cazelais/187/trapezoidal\\_rule.pdf](http://pages.pacificcoast.net/~cazelais/187/trapezoidal_rule.pdf)

## 2.3 Equilibrium Equations

Displacement will not be induced in a body if the sum of all the forces acting on it in each coordinate(x,y,z) is equal to zero. Therefore, letting  $F$  being a vector of magnitude  $|F|$  with components in  $x$ ,  $y$  and  $z$ , the first condition for a body to be in equilibrium is:

$$|F| = \sqrt{(F_x)^2 + (F_y)^2 + (F_z)^2} \quad (5)$$

$$\sum_{i=1}^n F_i = F_1 + F_2 + F_3 \dots F_n = 0 \quad (6)$$

$$\sum_{i=1}^n F_{i_x} = 0 \quad (7)$$

$$\sum_{i=1}^n F_{i_y} = 0 \quad (8)$$

$$\sum_{i=1}^n F_{i_z} = 0 \quad (9)$$

Nevertheless, the possibility exists that the body is not in equilibrium even though the summation of forces is equal to zero. An applied force will generate a moment about a point, in a body, around its centroid or centre of gravity. An applied moment to a body will induce rotation around an axis or several axes. Defining a moment as the vector cross-product of a position vector and a force vector (Felton and Nelson),

$$M_{F/A} = r \times F \quad (10)$$

and defining the position vector  $r$  and the force vector  $F$  as:

$$r = r_x \mathbf{i} + r_y \mathbf{j} + r_z \mathbf{k} \quad (11)$$

$$F = F_x \mathbf{i} + F_y \mathbf{j} + F_z \mathbf{k} \quad (12)$$

The second condition for equilibrium requires that the components of the moment vector must all be equal to 0:

$$M_{F/A} = r \times F \quad (13)$$

$$M_{F/A} = (r_y F_z - r_z F_y) \mathbf{i} + (r_z F_x - r_x F_z) \mathbf{j} + (r_x F_y - r_y F_x) \mathbf{k} \quad (14)$$

$$M_{F/A} = M_x \mathbf{i} + M_y \mathbf{j} + M_z \mathbf{k} = 0 \quad (15)$$

$$M_x \mathbf{i} = 0 \quad (16)$$

$$M_y \mathbf{j} = 0 \quad (17)$$

$$M_z \mathbf{k} = 0 \quad (18)$$

Ergo, for a body to be in static equilibrium, the summation of forces and moments acting on it must be equal to 0. Furthermore, it is easier to deal directly with the components of force and moment than with vectors especially since problems tend to be solved in two dimensional situations.

### 2.3.1 Equivalent Distributed Forces

Distributed forces are forces which don't act on an specific point but rather on a defined span. The span is defined by the number of dimensions used to represent the problem. A 1-D element

has force per unit length, 2-D force times unit area, 3-D force per unit volume.

Distributed forces can be represented in a single punctual force applied at the centroid of the span where the force is being applied. If the applied distributed force is constant, the equivalent applied force will be the multiplication of the span times the correct unit length, area or volume. The force will be only applied at the geometrical centre of this length, area or volume.

When the distributed force is not constant, it is necessary to integrate the area under the curve to determine the magnitude of the equivalent force as shown in the equation below.

$$F_{Eq} = \int_0^l q(x)dx \quad (19)$$

If the centroid cannot be determined geometrically, the centroid of the area must also be obtained by integration:

$$\bar{x} = \frac{\int_0^l xq(x)dx}{\int_0^l q(x)dx} \quad (20)$$

The equation above can be compared to calculating the average of the moment generated with respect to the point at 0. It can be observed in Figure 4, that the distributed force grows linearly along  $l$ , thus it is coherent that the equivalent force is applied to a value closer to  $l$ . If the function is not known, approximations as the trapezoid rule can be used for 1-D and 2-D models.

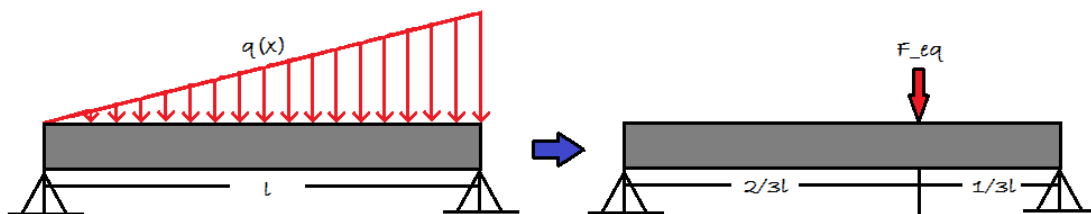

Figure 4: Equivalent distributed force

## 2.4 Stability

The statics of a floating body are reign by two opposing forces acting on it, gravity and buoyancy. Gravity accelerates the mass of the body generating the weight force which will be applied at the centre of gravity of the body  $G$ . Buoyancy is generated by the volume of water displaced by the floating water. The water displaced will attempt to return to the place it had before being displaced and consequently an upward force will be created. The magnitude of the buoyancy force is equal to the weight of water displaced by the floating body which is applied at the centre of buoyancy. The centre of buoyancy  $B$  is placed at the centroid of the body's volume immersed in water.

If a floating body is in static equilibrium, the summation of forces and moments acting on it is equal to 0. Therefore these two opposing forces must be equal in magnitude and applied on the same vertical line as shown in Figure 5 index (a). This line is referred as *axis of floatation*.

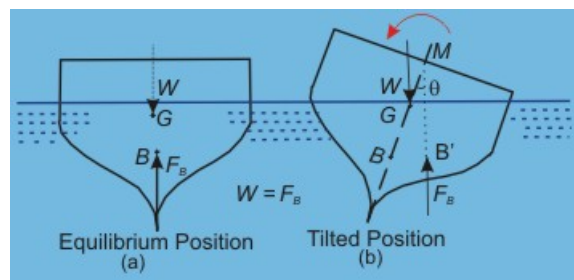

Figure 5: Floating body statics sketch

During operation, floating structures undergo a series of forces applied on them which are mostly due to waves and cargo loading. Their design allows them to withstand these loads and remain sufficiently stable to operate under these conditions.

Stability is the capacity of a body to return to its equilibrium position after it has been shift out of it by an external force. When a force is continuously applied to body at a distance  $l$  from the centre of gravity, a moment will be produced and the body will rotate and tilt. If the body is stable an opposing moment known as *righting moment* will be produced and the body will maintain a fixed tilted position.

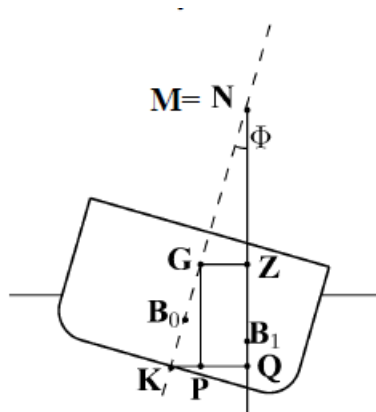

Figure 6: Sketch of a heeled vessel



On the axis of flotation, additional important variables are  $K$  and  $M$  which are the keel of a vessel or the lowest part of a floating body and the metacentre respectively. The keel is used as a reference to determine the position of  $B, G$  and  $M$ . As shown in Figure 6, when a floating body heels the centre of buoyancy shifts to  $B'$ . If a straight line upward is drawn from  $B'$ , the point where this line crosses the *axis of flotation* is the metacentre. Therefore the metacentre always lies above the actual centre of buoyancy.

For a floating body to be stable it is required that the metacentre is above the centre of gravity, otherwise the *restoring moment* will contribute to any moment applied by external forces resulting in the body turning upside down. The distance from the centre of gravity to the metacentre is denominated *metacentric height* or  $GM$ . Hence, the smaller the value of  $GM$  is, the smaller the *righting moment* will be and consequently a loss in stability is produced.

If an horizontal line is drawn from  $G$ , the intersection with the line drawn from  $B'$  is  $Z$ . The distance from  $G$  to  $Z$  is denominated as *righting arm* or  $GZ$  and is defined as:

$$GZ = GM \sin(\phi) \quad (21)$$

The magnitude of the *righting moment* is directly proportional to  $GZ$ . Furthermore, it is possible to evaluate the stability of a floating body just by plotting the resulting lever arm against the angle  $\phi$  of heel that produces it. This plot is known as *GZ-curve*. An example is displayed at Figure 7.

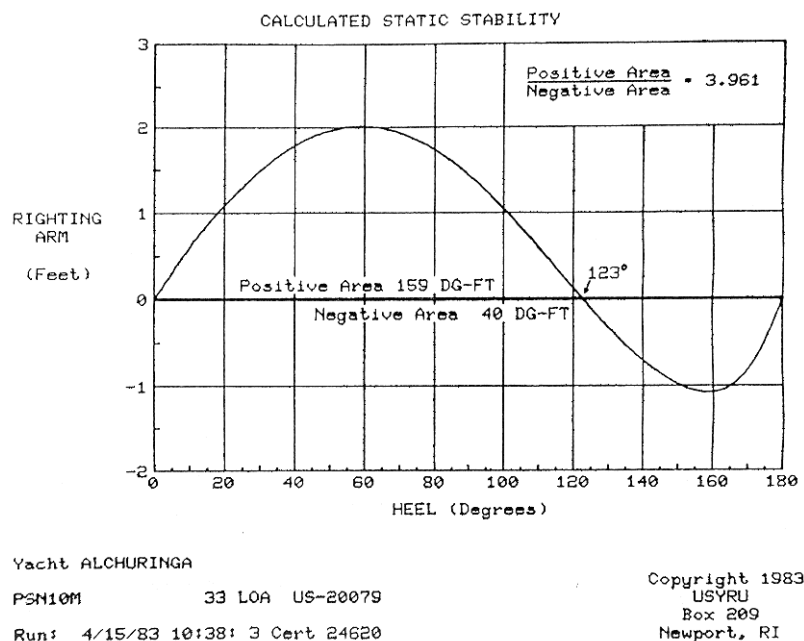

Figure 7: GZ-curve

Available: <http://www.fundacaoacsantos.pt/wp-includes/js/gz-curve>

The *righting moment* can then be defined as:

$$RM = GZ \times W \quad (22)$$

From this equation, it is possible to derive other parameters which are widely used during operation planning of floating bodies and their design properties. These are *the moment to change heel 1°* (MHD) and *the moment to change trim 1 cm* (MTC). Starting from the definition of the *righting moment*, *MHD* is derived as:

$$MHD = GZ \times W \quad (23)$$

$$MHD = \tan(\phi) \times GM_T \times W \quad (24)$$

Where  $\phi$  is equal  $1^\circ$ ,  $GM_T$  stands for the transversal metacentre and  $W$  for weight or displacement. The same theory applies for trimming, thus continuing from the equation above, *MTC* is defined as:

$$MTC = \tan(\phi) \times GM_L \times W \quad (25)$$

$$MTC = \frac{0.01}{L} \times GM_L \times W \quad (26)$$

$$MTC = \frac{W \times GM_L}{100L} \quad (27)$$

Where  $GM_L$  is the longitudinal metacentre and the  $L$  is the vessel's LOA.

### 3 PROJECT DESCRIPTION

A vessel will be transferred to a floating dock through a trolley transfer system or *TTS*. Before the transfer operation begins, the dock will be pre-ballasted and fixed to two shore beams by pressure. As shown in Figure 8, the moment generated as consequence of pre-ballasting will apply a force on the shore beams fixing the dock at 0 deg. To avoid sway and heaving, the dock is kept in place while attaching two dolphins to the side.

Both shore beams have installed load cells which monitor constantly the force applied on them. In order for the transfer to be successful, the value of the force must always be in the range of 450-50 tons per load beam or 900-100 for the two load cells installed on the dock. The maximum force bearable by a load cell is 500 tons, if higher, the shore beam will break and an extreme situation may emerge.

Additionally, if the readings on the load cells are smaller than 0 tons, the shore beams will have no contact with the quay and the rails under the trolleys will separate.

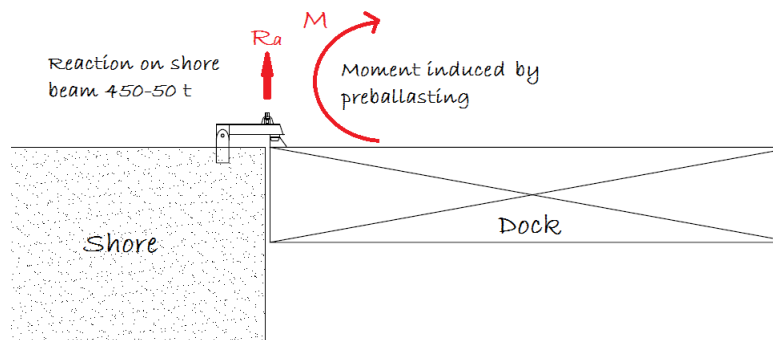

Figure 8: Two shore beams will keep the dock at  $0^\circ$

In the following subsections the dock and all systems involved in the transfer will be described. Obtaining all possible data and understanding the transfer process is vital for the development of the algorithm that will control the process.

#### 3.1 The dock

The floating dock's dimensions and hydrostatic data are shown in Table 2. A 3-D sketch is shown in Figure 9 and in Figure 10 drawings of all 3 planes (*xy*, *xz*, *yz*) are shown.

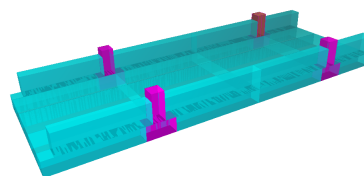

Figure 9: 3D view of floating dock

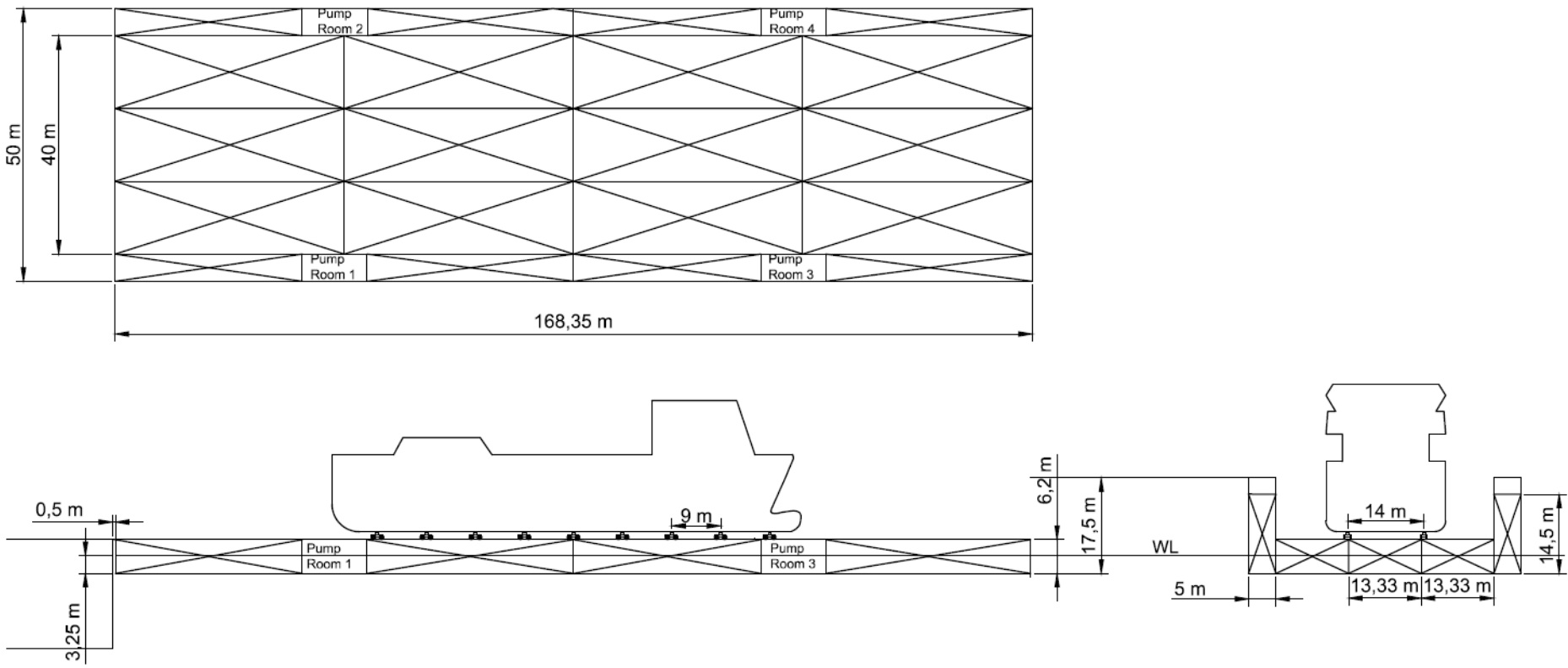

Figure 10: Sketch of the dock

<b>Description</b>	<b>Value</b>	<b>Units</b>
Dock ship transfer capacity	5000	<i>t</i>
Length	168.35	<i>m</i>
Breadth	50	<i>m</i>
Draught	3.325	<i>m</i>
Displacement	28315	<i>t</i>
Pontoon height	6.2	<i>m</i>
Pontoon breadth	40	<i>m</i>
Centre of gravity ( <b>Xg</b> )	0	<i>m</i>
Centre of gravity ( <b>Yg</b> )	0	<i>m</i>
Centre of gravity ( <b>Zg</b> )	3.31	<i>m</i>
Distance from Xg to ramp	84.175	<i>m</i>
Corrected longitudinal GM	647	<i>m</i>
Moment to change trim 1 cm	1091	<i>t · m/cm</i>

Table 2: Dock specifications

### 3.1.1 Important Design and Operational Specifications

By design, the dock must respect certain conditions and restrictions to remain operational. Most of these restrictions must be considered during the development of the dock's automation system. In tables 3 and 4 the permissible wind pressure and the minimum required free board to transfer a ship are given.

<b>Maximum Wind Pressure</b>	
Submerging and floating up	400 Pa
Transfer operations (Shore/Dock & Dock/Shore)	100 Pa
Operation of cranes	400 Pa

Table 3: Operational Wind Pressure

<b>Dock's free board</b>	
At maximum submerging	2 m
At sea level +2.46 to 2.6, minimum to transfer	0.2 m

Table 4: Freeboard operational limits

Additionally, the dock can not be locked to the shore beams during storms conditions. This prevents any damage to the load cells which are a key devices to the transfer operations control system.

During the development of the algorithm, the most important system to be familiarized with is the ballast tank system. Its restrictions and limitations are shown below:

- During submerging the difference in level between adjacent tanks at maximum pressures should not be greater than 1 m.
- Empty ballast tanks are not allowed during submerging of the dock.
- Special ballasting required to decrease the dock's bending moment shall be determined before the docking operations.
- Transfer of a ship to the submerged dock shall be performed from the fore end side by means of tugs.
- The dock will be powered electrically from the shore.
- An emergency diesel-generator will supply power in emergencies.

## 3.2 Transfer Master System Specifications

The Transfer Master System is the system in charge of transfer operations. It is composed by several subsystems that work together to execute the transfer operation successfully. This subsystems are a combination of sub control and monitoring systems that are centralized to a main operation system. This subsystems are:

- Simulation Modelling
- Automatic Control System
- Vessel Blocking Control
- Dock Ballast Control
- Monitor Sensors

### 3.2.1 Simulation Modelling

The simulation modelling is responsible of generating a parameter based ballast procedure for the transfer operation. The simulation must determine and display the next unknowns for the whole process:

- Dock sitting (position) during launching.
- Ballast distribution in dock's ballast tanks.
- Dock's deflection.
- Moment's deflection.

The input required for the simulation can be divided in two categories, variable and constant parameters. Variable parameters are the ones modified by the dock master to obtain different ballast sequences. They control directly the outcome of the simulation:

- Number of trestles
- Load from vessel per trestle
- Distance between trestles
- Trolley Speed
- Coordinates of trestles on Dock's pontoon deck respect to the dock's centre of gravity.
- Dock's draught at current sea level.

Constant parameters depend solely on the vessel. They are key information required for the transfer to be planned and simulated. Changing any of these parameters means modifying the dock itself. The constant parameter classification for this simulation is presented in the following table:

<b>Dock technical characteristics</b>
-Dock light weight -Centre of gravity -Length and width of pontoon
<b>Vessel blocking system technical characteristics</b>
-Weight of trolleys -Weight of trestles
<b>Ambient characteristics</b>
-Water density in the area

Table 5: Constant parameters

Even though there are some limits specified by design, the dock master must be able to widen or further restrict these limits based on current situations. Additionally, this provides flexibility in simulation making the analysis of different docks possible as well. These parameters are referred as *programmable parameters* and are listed below:

<b>Programmable Parameters</b>
-Permissible dock deflection -Permissible moment of deflection of the dock -Permissible trim difference in dock -Heel of dock (not PERMISSIBLE)

Table 6: Programmable parameter

The simulation must display results through each ballast sequence. This facilitates problem detection and variable parameter adjustment. The number of ballast sequences proportioned by the simulation is equal to the number of trestles required plus one initial and one final sequence.

### 3.2.2 Automatic Control System

The Automatic Control system is responsible for executing the ballast sequences determined by the simulation process. All processes ran at the floating dock must be semi-automatic, therefore there are requirements to fulfil for this implementation:

- A web-based system so that the transfer operations can be monitored remotely.
- Separate industrial computer which is architecturally on top of the Ballast control system.
- Combination of Automatic and Manual Control possible.
  - Automatic control → START, PAUSE, STOP, RESUME, switch to manual
  - Manual control → Control on each valve and pump, switch to automatic.

The automation of a floating dock must consider the ballast tank capacity and response time which depends on the pumps and valves implemented. Specifications such as pump capacity and continuous operation time, and valves opening/closing times should be taken into consideration.

### 3.2.3 Vessel Blocking Control

The vessels Blocking System refers to the transfer system utilized and the docking system that sustains the vessel. The vessel is sustained by trestles and each trestle is transported by a pair of trolleys. As shown in Figure 11 trolleys are grouped in 3 different groups:

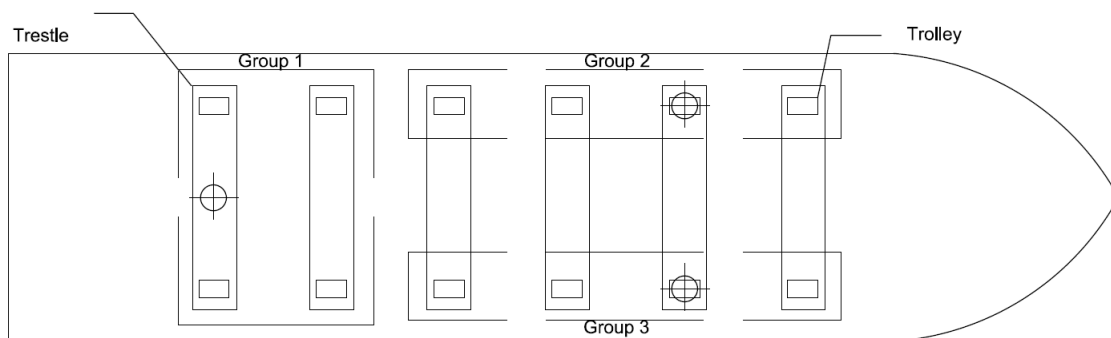

Figure 11: Distribution of trolleys

Figure 11 is mainly an illustration, the number of trolleys in one group as well as the group positioning along the vessel can vary. The only fixed requirement is that all trolleys in one group carry approximately the same weight.

The reason is that all trolleys are powered by one car which provides a total pressure to each group. Consequently, due to pressure laws this total pressure will be distributed in all trolleys equally. It is assumed that all trolleys have the same dimensions.



During the transfer process, when the first trolley is at quay side and the load cell in the shore beam has the correct pre-loading value, the trolleys will move and the transfer will start. The speed of the trolleys must be controlled based on the readings from the load cells. This ensures that the trolleys can reduce their speed or be stopped automatically when the value at the load cell is close to 500 t.

Table 7 and Figure 12 present general data on the vessel blocking system.

Approximate trolley weight	7 tons
Approximate trestle weight	23 tons
Minimum distance between trestles	4.8 m
Maximum load on a trestle	650 tons
Trolley nominal speed	2 m/min
Trolley maximum vertical variation	100 mm

Table 7: Vessel Blocking System Specifications

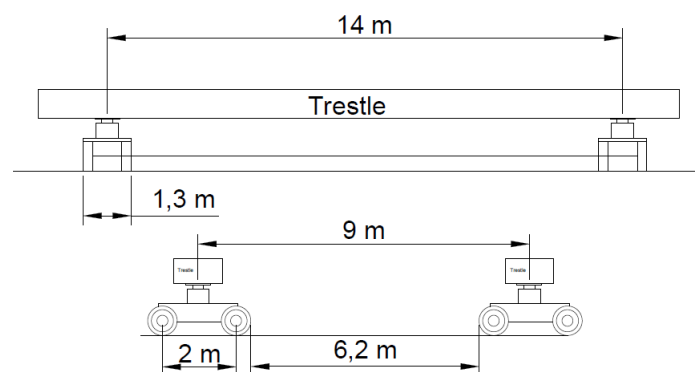

Figure 12: Trolley specifications

### 3.2.4 Dock Ballast Control

The Dock Ballast Control is responsible for controlling the pump and opening and closing the valves. The pumps are frequency controlled meaning that depending on the resolution they are operational in any value between their minimum and maximum capacity.

Initially, a gravity based filling system was proposed, meaning that pumps were intended only for removing water from the ballast tanks. An analysis was made to determine the volumetric flow possible. There is one vent located at the bottom of each tank and they have a circular shape. It is assumed that the air will flow out of the tank through a vent whose diameter should be 1.5 times greater than the vent where water flows in. If not the case, the floating dock could not be accepted by class societies.

Figure 13 was used as a reference sketch and the following information was utilized for calculations:

Vent diameter	0.6 m
Water density	1.01 t/m <sup>3</sup>
Gravity acc.	9.81 m/s <sup>2</sup>
Air density 10 <sup>(o)</sup> C	0.0012466 t/m <sup>3</sup>

Table 8: Data utilized for calculations

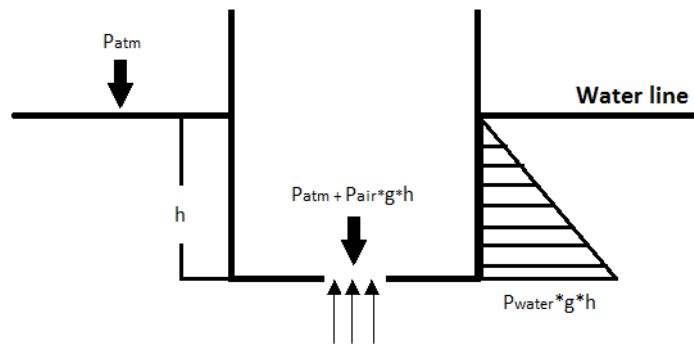

Figure 13: Sketch used for calculations

The volumetric flow rate is determined as follows:

$$Q = C_{fluid} \times A \quad (28)$$

Where  $C$  is the fluid speed and  $A$  is the vent's area through which the liquid is flows. But since factors as friction and the vent's location reduce the speed of the fluid, this approach is considered as theoretical. To compensate this loss, the theoretical result is multiplied by a constant  $\mu$  which is always smaller than 1. This constant is determined from tables where different configurations for the vent are considered. For this case  $\mu$  is equal to 0.61.

For the calculation of the stream's theoretical speed, Torricelli's formula was used, the formula for the general case is shown below,

$$C = \sqrt{2 \times \frac{\Delta p}{\rho}} \quad (29)$$

The speed varies mainly through  $h$  which is the height from the water line to the vent. Two draught levels were used for the calculation 3.325m and 15.5m. This two values correspond to the draught required for transfer operations and the draught when the dock is submerged completely.

$\Delta p$  is the difference between the pressure that forces the fluid out and the pressure which forces the fluid to stay in. The atmospheric pressure forces the liquid in and out, so its effect has been neglected. Only the pillar of air from the water line to the bottom of the tank has been taken into account, this pressure is relatively small, so it can be also negligible if desired.

As water fills the tank, a back-flow will be generated. This back-flow reduces the pressure difference, thus reducing the stream speed. Therefore, the volumetric flow was determined by each meter the water level raised inside the tank.

The results for both draughts are shown in the table below and plotted in Figure 14,

Meters (m)	Q - 3.325 m ( $m^3/h$ )	Q - 15.5 m ( $m^3/h$ )
0	4932	10771
1	4104	10417
2	3059	10052
3	1368	9672
4	—	9277
5	—	8865
6	—	8432
7	—	7976
8	—	7492
9	—	6975
10	—	6416
11	—	5796
12	—	5118
13	—	4325
14	—	3351
15	—	2736

Table 9: Volumetric flow at different water levels

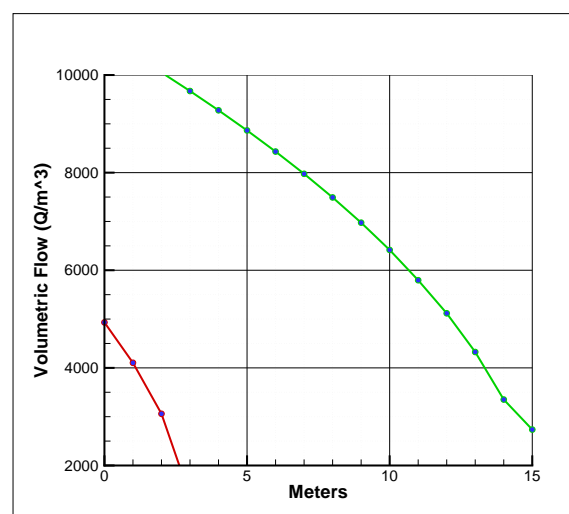

Figure 14: Volumetric flow at different water levels

From the analysis it can be concluded that gravity filling is not suitable for an automatized dock ballast system. The reasons are the following:

- Even if the volumetric flow reaches high values, its value reduces as the tank fills, thus it is not possible to set the volumetric flow at a fixed rate.
- Valve opening and closing time is vital for this kind of system, having the valves open at a certain percentage while water is flowing makes the process less controllable.

2	Pump	4	6	Pump	8
10		12	14		16
17		18	19		20
9		11	13		15
1	Pump	3	5	Pump	7

Figure 15: Actual tank configuration

Therefore, all pumps in the system are taken as reversible. Pumps have a maximum capacity of  $3000\text{ m}^3/h$  and each one pumps water to five different tanks. There is a total of 20 tanks and 4 pumps in the system. The actual pump-tank configuration is shown at Figure 15, still a new configuration has been proposed and shown in Figure 16. This configuration is expected to facilitate ballast sequence planning and if required two pumps can work on a group of five tanks simultaneously.

2	Pump	4	6	Pump	8
10		12	14		16
17		18	19		20
9		11	13		15
1	Pump	3	5	Pump	7

Figure 16: Proposed tank configuration

Each tank has different capacities which are shown in Table 10. The centre of gravity of each tank is a requirement for the righting moment calculation. The centre of gravity of each tank is shown in Figure 17.

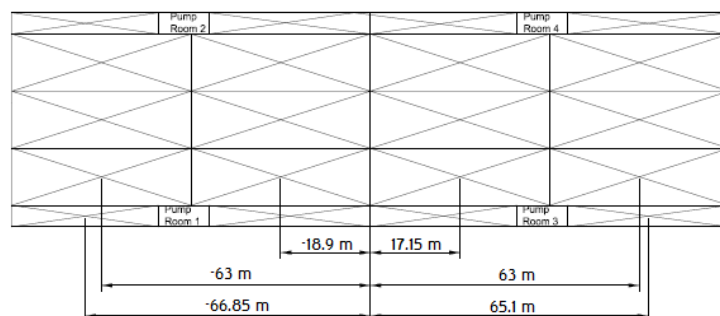

Figure 17: Tanks centre of gravity

<b>Tank</b>	$m^3/h$	<b>Tank</b>	$m^3/h$
Tank 1	2385	Tank 11	3163
Tank 2	2385	Tank 12	3163
Tank 3	2883	Tank 13	3117
Tank 4	2839	Tank 14	3117
Tank 5	2534	Tank 15	3162
Tank 6	2578	Tank 16	3162
Tank 7	2831	Tank 17	3812
Tank 8	2831	Tank 18	3864
Tank 9	3117	Tank 19	3812
Tank 10	3117	Tank 20	3864

Table 10: Tank maximum capacity

### 3.2.5 Monitor Sensors

The Monitor Sensor System logs of all parameters during transfer. The correct development and installation of this system is vital for all the dock processes since it allows supervision of all operations and revision of the floating dock status. The main features are listed in Table 11.

Control	Stress Control Deflection sensor (2-D deflection curve) Sounding Control (Fill percent / volume /level / weight of tanks) Heel/Trim control Load cell reading Draught of dock (Graphical dock floating condition display) Tide display Speed/Stop of trolleys
Monitoring	Machinery, gears, and systems in operation <ul style="list-style-type: none"> <li>-Pump RPM / Water volumetric flow per pump</li> <li>-Pump and valve status</li> <li>-Pump engine temperature / current</li> </ul> Information on failure of machinery, gears and systems. <ul style="list-style-type: none"> <li>-Computer logging and reporting</li> </ul>

Table 11: Monitor sensor system specifications

When the system detects values outside the predefined ones, an alarm must be given. Alarms can be provoked due to system failures or operational failures. Operational failures are generated by situations such a high heeling angle or tank overflowing. System failures are mainly

due to sensor dysfunctions.

If necessary, during emergencies the operator can stop the operation of any system or all and shift to manual control. The alarm system must fulfil the following minimum requirements:

- Visual alarm for systems and operation failures.
- Individual alarming of system failure.
- Individual alarming of operational failure.

### **3.3 Transfer Operation Description**

Floating dock operations vary greatly from vessel to vessel, independently from any kind of operation, the dock master must receive prior to dock planing and transfer simulations the following information from the incoming vessel:

- Principal dimensions (LOA, breadth, draught, displacement)
- Sectional Lightweight
- Frame Distance Information (trestle spacing)
- Hydrostatic table

Once the information received is processed, the operation can be planned, executed and controlled. The general procedure is as follows:

1. All parameters are given as input and the simulation is executed.
2. The distribution of ballast on ballast tanks per sequence to control the dock's draught and trim is obtained.
3. Actual ballast tank distribution is received by the dock ballast control subsystem.
4. Pre-loading of the dock with a load between 50 to 450 tons.
5. Trolley displacement begins and transfer starts.
6. Monitoring is performed during the process.
7. When deviation from permissible parameters is detected, the ship transfer is stopped and then ballast system will return the values back to normal and transfer will continue.
8. If there is problems with the transfer trolleys or with the ballast system the transfer is stopped until the problem is fixed.

## 4 STATIC ANALYSIS

An non existing vessel with the following characteristics and assumptions served as base to analyse the transfer process in detail.

Lightweight	5000 t
Lightweight distribution	Constant
LOA	85 m

Table 12: Vessel specifications used for transfer analysis

Since the vessel embodies a constant light weight distribution, the vessels LCG is positioned at its centre at  $42m$ , furthermore the span between trolleys was fixed to  $9m$  and the selected number of trolley pairs placed under the vessel is 9.

$$weight \times trestle = \frac{5000}{9} = 555.55tons \quad (30)$$

The weight per trestle limit was not breached, hence the configuration is acceptable and the analysis of the transfer can be carried out. In order to have a deeper understanding on the transfer, the analysis was divided in 3 steps:

- Meter per meter moment calculation
- Righting moment vs Transfer Moment
- Moment calculation with trim and draft control

### 4.1 Meter X Meter

In this analysis, the dock is considered as a rigid body which will not move and no control over the load cell is required. The objective is to have a detailed moment graph to observe the evolution of the applied momentum during the transfer. It is understood that the weight is transferred from the vessel to the trestles, from the trestle to the trolleys, following until reaching the trolley wheels. Assuming that the trolleys sustaining the trestles are perfectly aligned and that the weight is distributed equally among them, there are 2 lines of wheels which apply the weight per trestle. Each lines consists of four wheels and they will be referred as *lines of action*. Each line of action will be applying the following force:

$$weight \times wheel = \frac{weight \times trestle}{2} = 277.77tons \quad (31)$$

In order to reach static equilibrium, the vessel's LCG must be positioned in-line with the floating dock's LCG. The distance that the vessel must advance in order to reach this equilibrium point is the distance from the floating docks LCG to the initial position plus the distance from the vessels LCG to the first trolley. As a result of having a trolley being positioned right under the vessel LCG, the value of this distance to equilibrium is simply:

$$Distance \ to \ equilibrium = LCG_{vessel} + 4 \times 9m \approx 120m \quad (32)$$

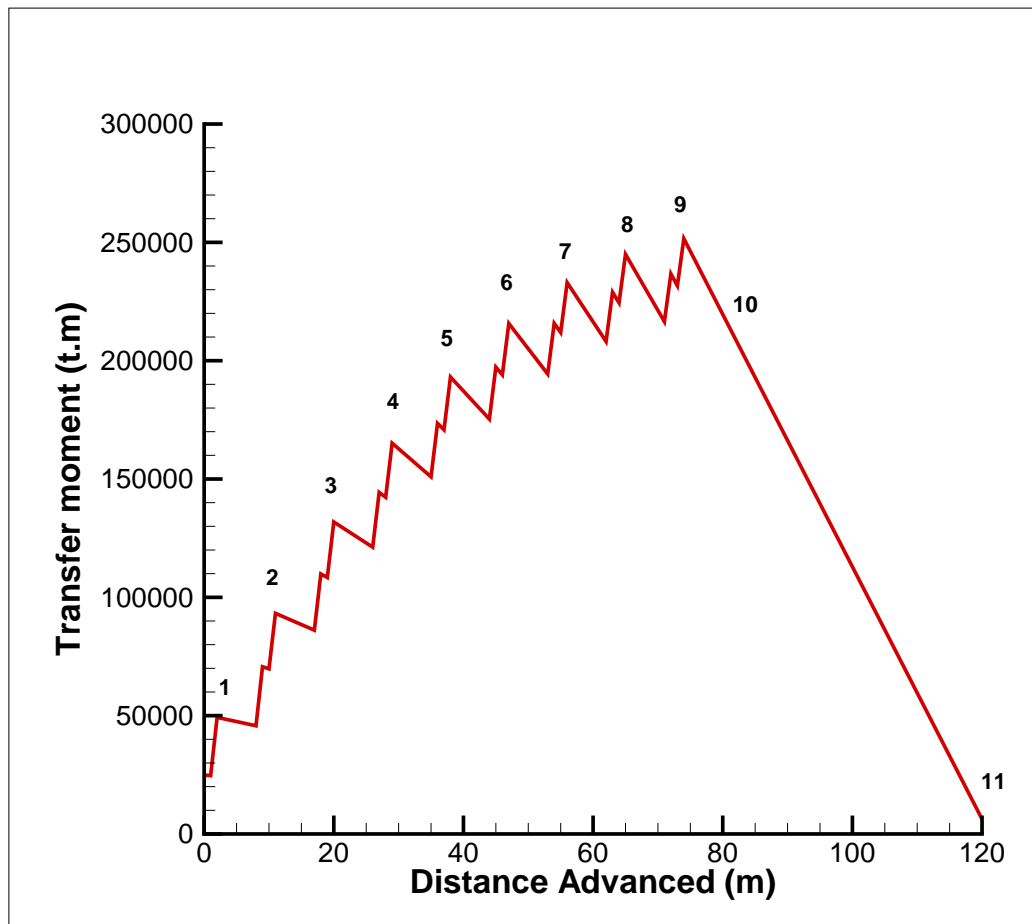

Figure 18: Moment meter X meter

Figure 18 shows the momentum curve plot for the transfer. From 1 to 9, each number signals the point when a trestle is placed fully on the dock during the transfer. Each peak represents a line of action, small peaks are generated by the trestle's first line of action and the big peaks by the second one.

At position 9 the vessel is supported completely by the floating dock. As result of not placing more weight on the floating dock, it is observed from points 10 to 11 that the moment is reduced while the vessel gets closer to the floating dock's LCG until it reaches zero.

The peaks generated by the trestle's second line of action produce the highest moment values during the transfer, therefore it is possible to divide the transfer in sequences. Since the values in between are smaller than the peak values, approximation by linear interpolation can be done. Furthermore, it will be refrained from working with average values because these peaks are possible damage risk to the load cell if not considered.

## 4.2 Righting Moment vs Transfer Moment

In this analysis it was attempted to follow transfer moment curve with the righting moment curve by manually modifying the water level in the ballast tanks. The objective of this analysis is to understand the key variables that influence the righting moment generation.



Taking into consideration the first analysis conclusions, the transfer was divided in 11 loading sequences. Case 0 is defined as the state of the dock before the transfer and sequence 10 the state of the dock when the transfer has been completed. From sequence 1 to 9 the transfer is described. Loading sequences from 1 to 10 are described graphically below. Information as the transfer moment and the distance advanced per sequence is proportioned.

### 1.-Loading Sequence 1

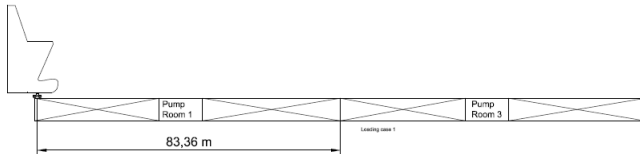

Distance advanced: 2 m  
Momentum : 49,285.81 t.m

### 2.-Loading Sequence 2

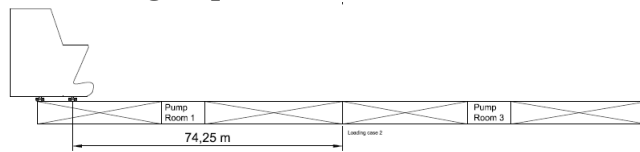

Distance advanced: 11 m  
Momentum : 93,238.52 t.m

### 3.- Loading Sequence 3

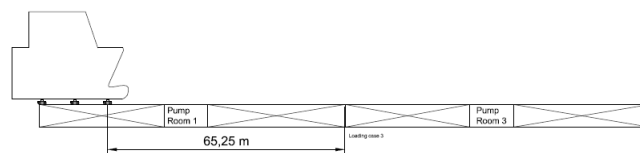

Distance advanced: 20 m  
Momentum : 131,858.43 t.m

### 4.- Loading Sequence 4

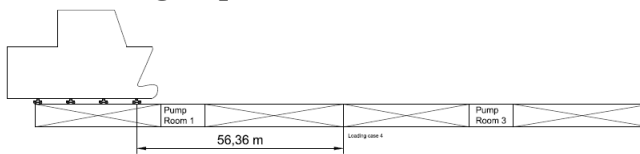

Distance advanced: 29 m  
Momentum : 165,145.23 t.m

### 5.- Loading Sequence 5

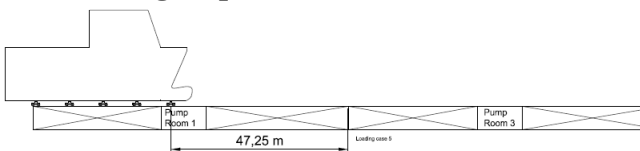

Distance advanced: 38 m  
Momentum : 193,099.04 t.m

### 6.- Loading Sequence 6

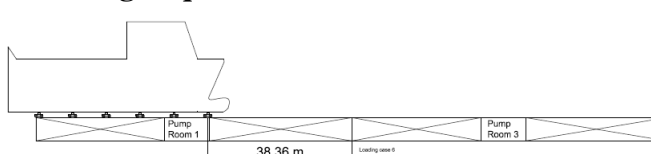

Distance advanced: 47 m  
Momentum : 215,719.85 t.m

### 7.- Loading Sequence 7

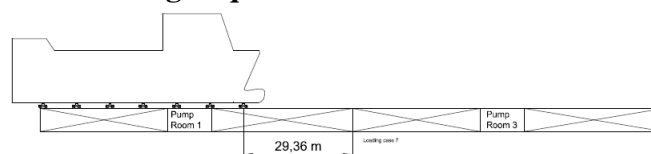

Distance advanced: 56 m  
Momentum : 233,007.66 t.m

### 8.- Loading Sequence 8

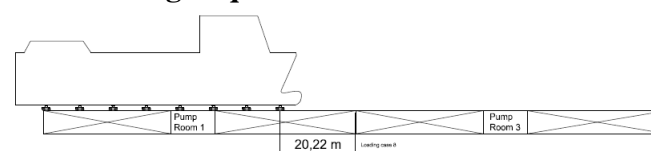

Distance advanced: 65 m  
Momentum : 244,962.47 t.m

**9.- Loading Sequence 9**

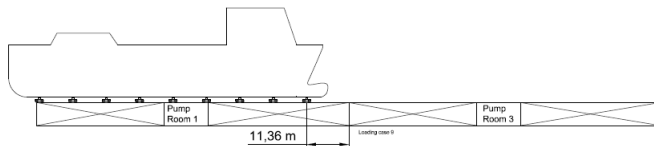

Distance advanced: 74 m  
Momentum : 251,584.28 t.m

**10.- Loading Sequence 10**

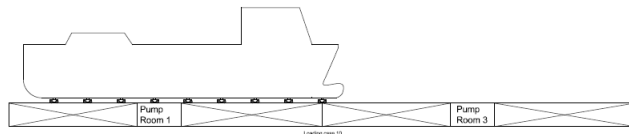

Distance advanced: 85.18 m  
Momentum : 170,656 t.m

**11.- Loading Sequence 11**

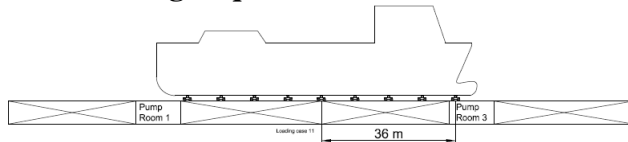

Distance advanced: 121.18 m  
Momentum : 0 t.m

The sea water density at which the floating dock will be located is  $1.01 \frac{t}{m^3}$  and the gravity acceleration value used for calculations is  $9.81 \frac{m}{s^2}$ . Using as reference the dock ballast control specifications, the maximum tons per minute that the pump can supply is determined:

$$Pump\ capacity = [3000 \frac{m^3}{h}] \times [\frac{1}{60} \frac{h}{m}] \times 1.01 \frac{t}{m^3} = 50.5 \frac{t}{min} \tag{33}$$

The quantity of water that the pump is able to supply or remove depends directly on the time between loading sequences. The trolley speed between sequences is key to the definition of this time. As a first approach, a standard velocity profile proportioned by the designer is used. The velocity profile can be observed at Figure19 with a yellow label and it is referred as "Actual Speed".

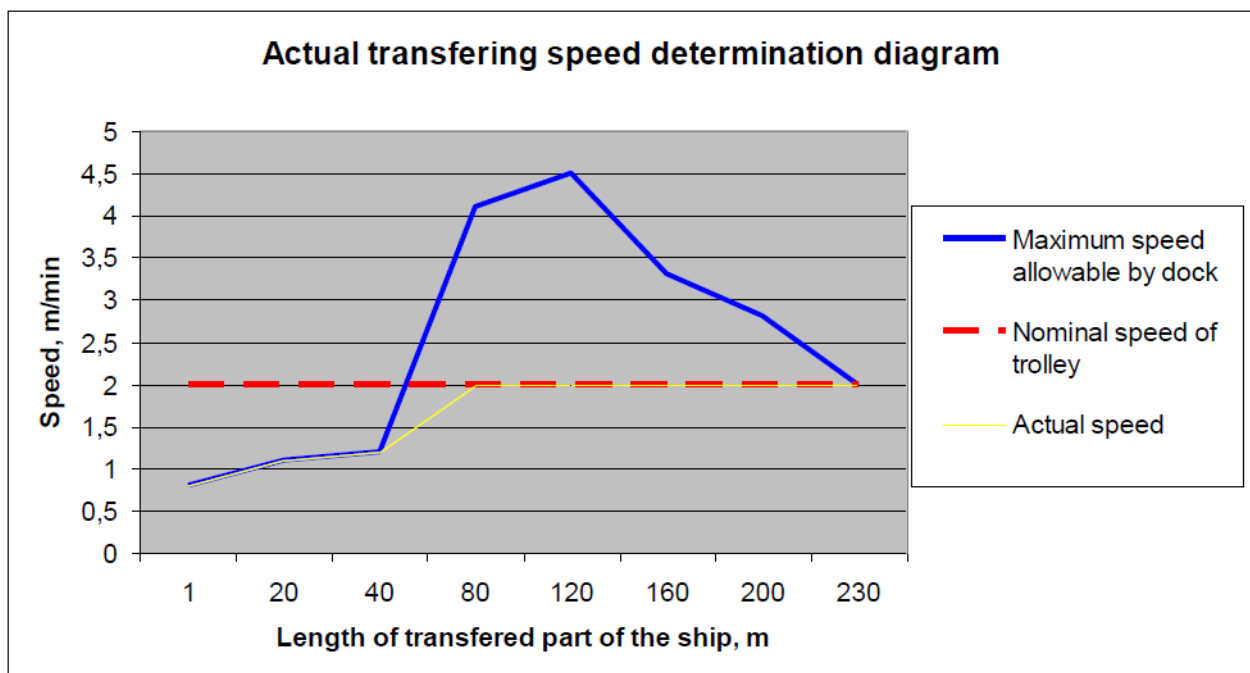

Figure 19: Designated trolley speed by designer

The velocity profile is not constant for the first eighty meters, still it increases linearly and the speed of the trolleys at any distance can be obtained by linear interpolation. The equation for linear interpolation is:

$$y = y_1 + (y_2 - y_1) \frac{y_1 - y_1}{x_2 - x_1} \quad (34)$$

In total there are three increases of speed, each with different slopes. This changes occur from 0 – 20, 20 – 40, 40 – 80 meters. The equations that define these increases are:

$$0 - 20 (m) \rightarrow y = 0.0158x + 0.78620 - 40 (m) \rightarrow y = 0.005x + 140 - 80 (m) \rightarrow y = 0.198x + 0.4 \quad (35)$$

Using the equations above, a maximum theoretical ballast system capacity study is carried out. In this study, only water at the furthestmost tanks is removed or added because of their LCG which produces the biggest moment. The assumptions for this study are that the tanks can never get full or empty and that the pumps can operate continuously at their maximum capacity without damage.

Three maximum capacities can be defined depending on the number of pumps applied. One pump corresponds to  $3000 \frac{m^3}{h}$ , two pumps to  $6000 \frac{m^3}{h}$  and four pumps to  $12000 \frac{m^3}{h}$ . At  $3000 \frac{m^3}{h}$  and  $6000 \frac{m^3}{h}$  water is removed from one side of the dock while  $12000 \frac{m^3}{h}$  involves removing water from one side and adding water to the other. The righting moment curve of the three capacities is plotted together with the transfer moment and shown in Figure 20.

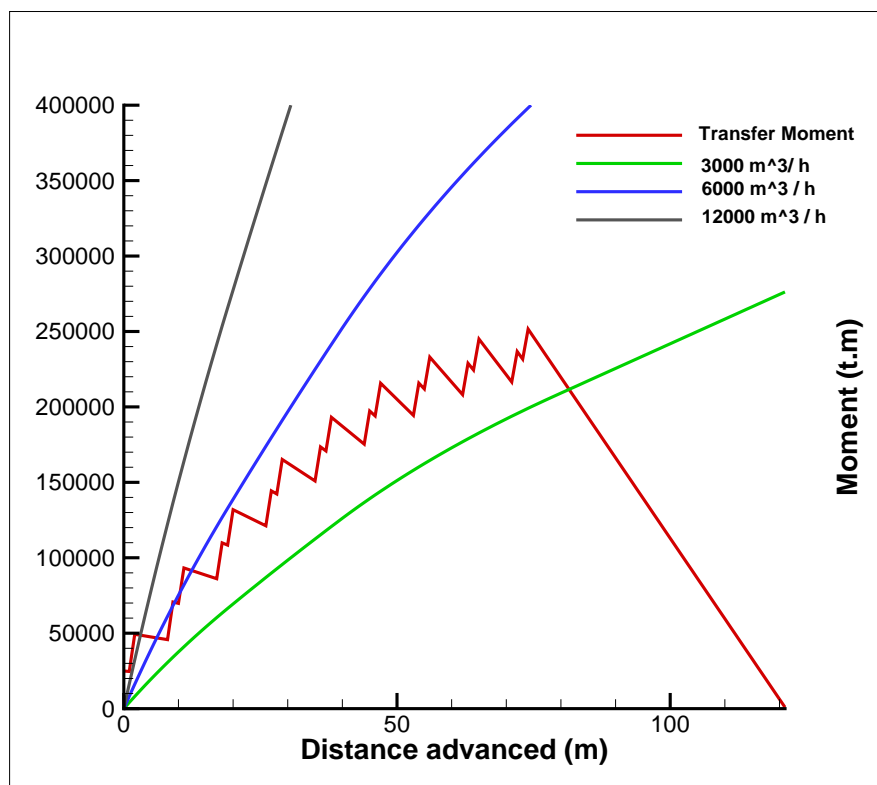

Figure 20: Ballast system maximum at different capacities

It can be seen that after some distance  $6000 \frac{m^3}{h}$  and  $12000 \frac{m^3}{h}$  are capable of handling the transfer moment. Considering that the tank capacity is not a limit in this study, the fact that

for the first few meters none of the three maximum capacities have time to respond, means that the trolley speed is too high for the ballast system to respond. Thus the trolley speed cannot be standardized or predefined and needs to be determined at each loading sequence.

Assuming that trolleys will always accelerate linearly, the equation slope of the increase between sequences can be determined always with linear interpolation. If this equation is integrated and divided by the square of the distance advanced, the total time between loading sequences can be determined without the necessity of calculating meter per meter like done previously. The standard time equation is:

$$time = \frac{x^2}{(m \times x^2) + (y_1 \times x)} \quad (36)$$

Where  $x$  is the distance advanced between loading cases in meters or  $\Delta x$ ,  $y_1$  is the speed of the previous loading sequence in meters per minute and  $m$  is the slope obtained with the following formula:

$$m = \frac{y_2 - y_1}{x_2 - x_1} \quad (37)$$

With the standard time equation, the theoretical possible quantity of water pumped and consequently the righting moment can be determined once a speed profile between sequences is given and a pump capacity at each sequence is chosen. It was possible to equal the righting moment with the transfer moment but the speed profile was modified and shown in Figure 21. It can be seen that it was necessary to reduce the trolley speed by half at the beginning of the transfer.

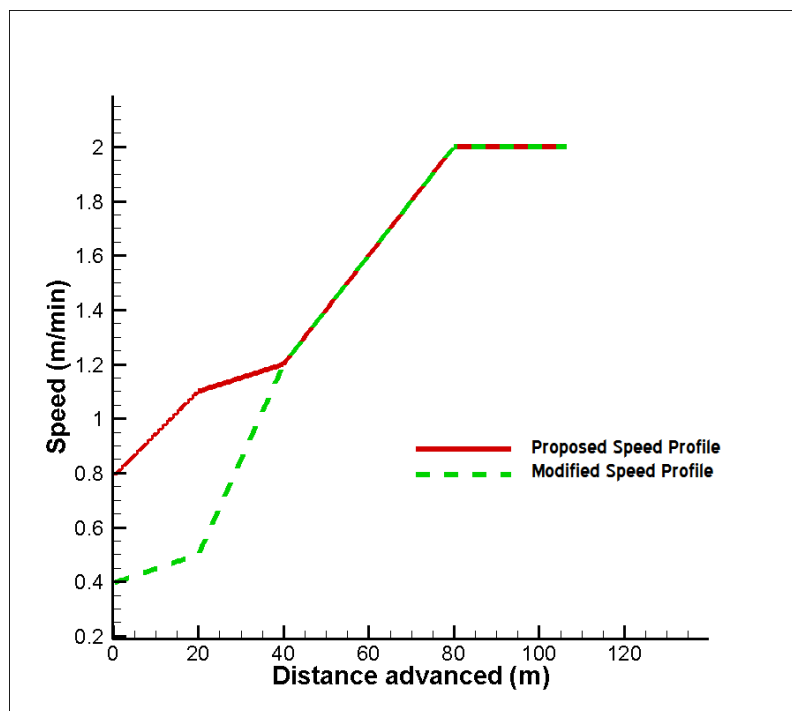

Figure 21: Comparison of trolley speed profiles

### 4.3 Moment Calculation with Trim and Draft Control

In this analysis, the load cell is simulated by having control over the changes of trim and draft that occur when water is pumped out and into the ballast tanks. The goal of this analysis is to follow the transfer moment curve with the righting moment while taking into consideration the limits and restrictions established by the systems involved in the transfer. The first limit is defined by the trolleys on the vessel blocking system which have a maximum vertical variation of 10cm thus the added variation of trim plus draft must not exceed this value.

Even though a certain degree of heeling is possible during the transfer operation, it was not permitted in this analysis. This implies that an even quantity of water was removed or added from all tanks selected, that tanks selected must have the same distance from their TCG to the floating dock's LCG axis and it is assumed the vessel will be transferred through the floating dock's LCG axis. Still, the heeling in all sequences was determined to avoid mistakes at the tank and pump capacity selection.

To calculate the trim at each section, the difference between the transfer moment and the righting moment was multiplied by a coefficient called "moment to change trim 1 cm" which is calculated in the following way:

$$MTC = \frac{\Delta \times GM_L}{100 \times L} \quad (38)$$

Where  $L$  is the length of the dock in meters,  $GM$  is the longitudinal metacentric height (m) and  $\Delta$  is the dock displacement in tons. There is approximately 0.25% difference between the result obtained by the formula above and the value specified by the designer, still for calculations the value given by the designer was favoured.

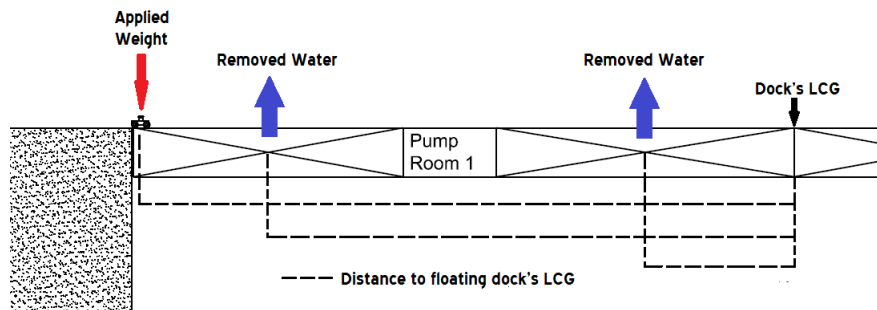

Figure 22: Lever arm difference between the transfer and righting moment

It is logical to think that if 650 tons are added on the dock, the same quantity of water would be required to be removed from the ballast tank system in order to maintain the draft unchanged. It is not the case at transfer operations because, as exemplified at Figure 22, the "lever arm" which produces the transfer moment is greater than the one that produces the righting moment, therefore, a greater weight needs to be removed to make both moments equal. To determine the change in draught the following equation is utilized:

$$\Delta T = T_{old} - [(\Delta_{dock} + W_{add} - W_{removed}) / (L_{dock} \times B_{dock} \times Shell\ factor)] \quad (39)$$

Where  $T_{old}$  is the draught of the dock before any change in weight occurred,  $\Delta_{dock}$  is the dock displacement in tons,  $W_{add}$  is the weight added and consequently  $W_{removed}$  is the weight removed,  $L_{dock}$  is the dock's length in meters,  $B_{dock}$  is the dock's breadth in meters and the *shell*

*factor* is a dimensionless constant applied to consider an increase in plate thickness due to manufacturing reasons. A value of 1.012 was utilized. The formula above was obtained assuming that from the bottom to the pontoon the dock is completely rectangular.

Using the formula to calculate the change in draft it is seen that a change in weight of 900 tons is approximately equivalent to  $+/- 10$ . Therefore, the trolley maximum vertical displacement and the load cell restriction can be considered as equivalent. As consequence, the results obtained during this analysis can be considered as representative of the transfer process.

In the first two analysis approaches the ballast systems limits were not considered, at this analysis, information regarding the tank filling state at a draught of  $3.325\text{ meters}$  with no vessel on the floating dock and the tank filling state at the same draught but sustaining a 5000 tons vessel was proportioned by the designer. This information is referred during the analysis as initial and final tank filling state respectively and the detailed information is proportioned in the tables below.

Tank	$m^3$	Tank	$m^3$		Tank	$m^3$	Tank	$m^3$
Tank 1	405	Tank 11	2459.40	⇒	Tank 1	296	Tank 11	898
Tank 2	405	Tank 12	2459.40		Tank 2	296	Tank 12	898
Tank 3	446.5	Tank 13	2459.40		Tank 3	325.7	Tank 13	898
Tank 4	491	Tank 14	2459.40		Tank 4	370.3	Tank 14	898
Tank 5	405	Tank 15	2544.4		Tank 5	296	Tank 15	935.6
Tank 6	445.5	Tank 16	2544.4		Tank 6	336	Tank 16	935.6
Tank 7	461	Tank 17	1508		Tank 7	339.6	Tank 17	1101
Tank 8	461	Tank 18	1508		Tank 8	339.6	Tank 18	1101
Tank 9	2459.4	Tank 19	1508		Tank 9	898	Tank 19	1101
Tank 10	2459.4	Tank 20	1560.4		Tank 10	898	Tank 20	1146.5

Table 13: Left → initial filling state, Right → final filling state

Calculations were done in an excel program and the detailed procedure and results are shown per sequence at the Appendix. The transfer moment and the righting moment curve are plotted per sequence at Figure 23. The difference between the two graphs is small because the maximum difference in momentum between them is:

$$\text{Maximum difference allowed in moment} = MTC \times 10\text{cm} = 10,910\text{t.m} \quad (40)$$

This value represents less than 5% of the maximum moment caused by the transfer. The difference between both moments is better appreciated in Figure 24 where the change of trim and draft per sequence is plotted as well as the total vertical displacement which is equal to the addition of the draft and trim per sequence.

The obtained velocity profile is plotted in Figure 25. It is observed that while transferring a ship of 5000 tons, the trolleys cannot reach their nominal speed. Furthermore, it can be conclude that for the first 40 meters of the transfer, the dock ballast system cannot keep up with the

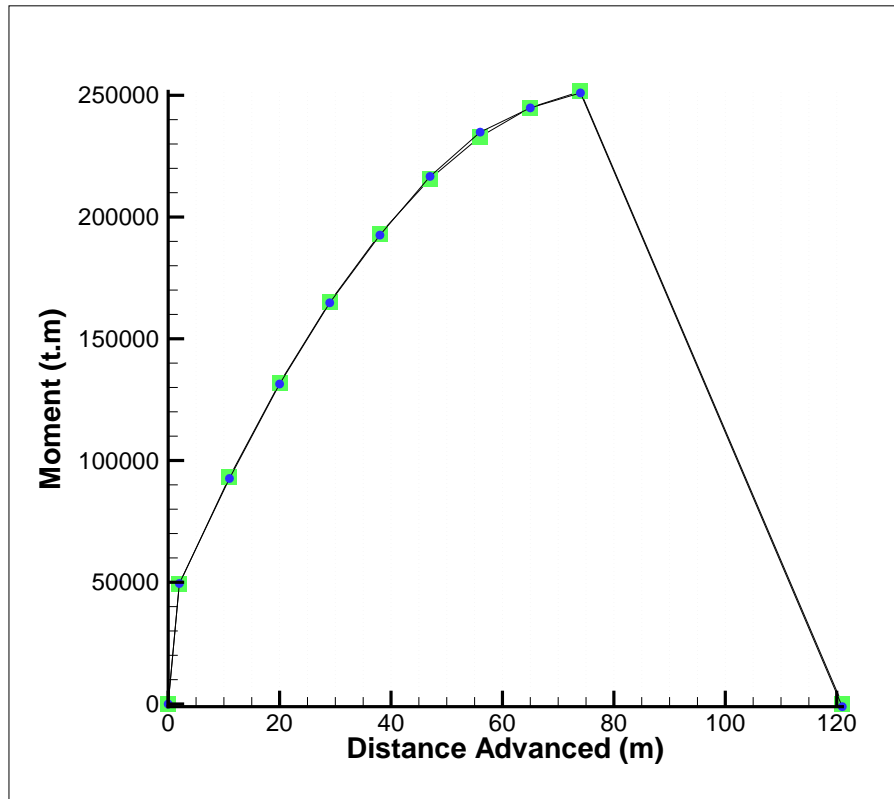

Figure 23: Moment comparison with control over draft and trim

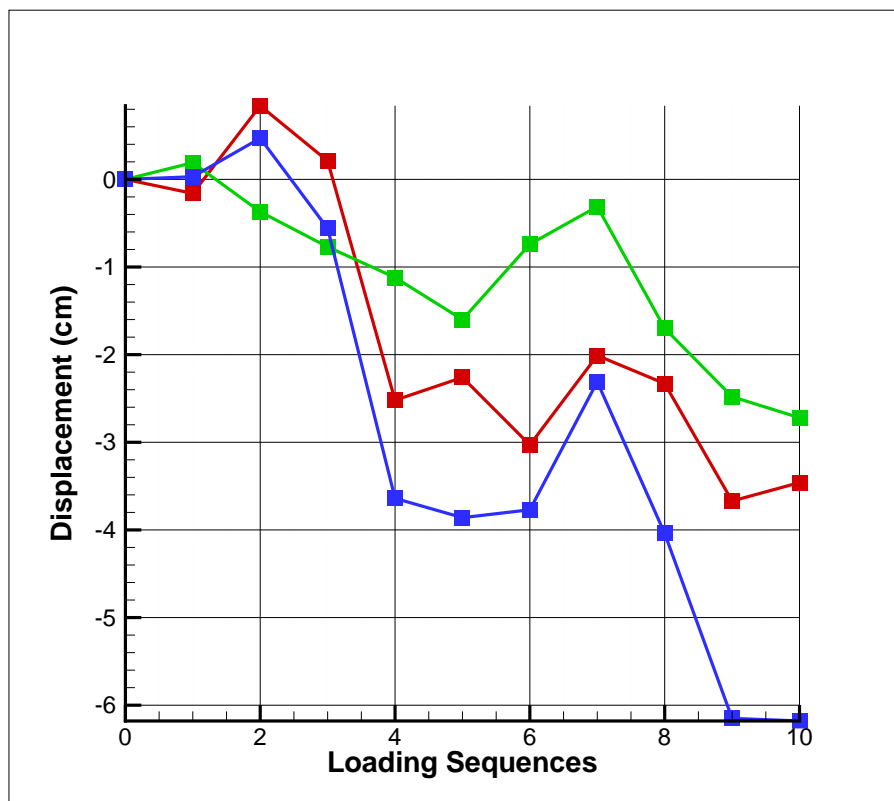

Figure 24: Trim, Draft and Total change during transfer sequences

trolley speed, as consequence, the transfer velocity must have low values during this initial 40 meters.

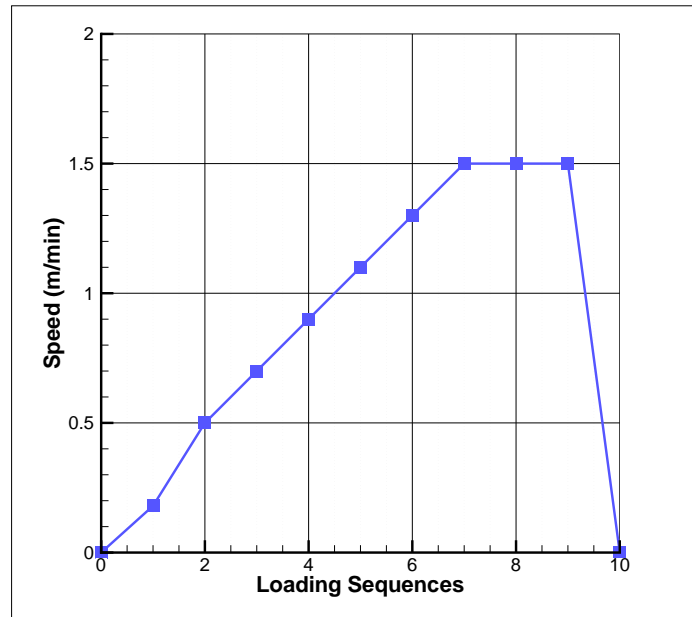

Figure 25: title

The ballast sequence plan is shown in the Table 15 and is plotted in Figure 26. Since tanks [9/10,11/12,13/14,15/16] will always work on pairs to avoid heeling. Their capacity and filling states have been joined together to reduce calculation variables. It is observed that the flow of water from the initial filling state to the final filling state varies more in the three tank lines parallel to the floating dock’s LCG axis. This was expected since these tanks have a much higher capacity than the side tanks.

<b>Tank</b>	<i>m</i>	<b>Tank</b>	<i>m</i>
Tank 1	1.80	Tanks 9&10	1.79
Tank 2	1.80	Tanks 11&12	1.76
Tank 3	1.64	Tanks 13&14	1.79
Tank 4	1.89	Tanks 15&16	1.83
Tank 5	1.69	Tank 17	1.79
Tank 6	1.89	Tank 18	1.77
Tank 7	1.74	Tank 19	1.79
Tank 8	1.74	Tank 20	1.84

Table 14: Final tank levels

Tanks on the sides [1,2,3,4,5,6,7,8] reach low filling levels but it is not a concern because of their low variation in water volume. It is hypothesised that vessels with a lower lightweight will not require the usage of this tanks or it will be minimum.



When the vessel arrives at the final loading sequence, all tanks must have approximately the same water level, for this transfer simulation the average level is of 1.78 meters. The final filling level is shown in Table 14. Therefore, this similitude in water levels is taken as a requisite for the final loading sequence of any other transfer.

During calculations it was searched to reach the highest trolleys speed possible between sequences to reduce the transfer operation time. The assumption is that the pumps can work at their maximum operational capacity of  $3000 \text{ m}^3/\text{h}$ . It can be concluded that the two most important variables to control during the transfer operation are the pump capacity and the trolley speed. These variables are mutually dependant.

Tanks	Loading Sequences										
	0	1	2	3	4	5	6	7	8	9	10
1	405.00	355.00	222.65	222.65	166.40	166.40	66.40	66.40	66.40	66.40	299
2	405.00	355.00	222.65	222.65	166.40	166.40	66.40	66.40	66.40	66.40	299
3	446.50	446.50	446.50	446.50	390.25	195.25	195.25	195.25	195.25	145.25	329
4	491.00	491.00	491.00	491.00	434.75	239.75	239.75	239.75	239.75	189.75	374
5	405.00	405.00	405.00	530.00	530.00	530.00	530.00	530.00	530.00	530.00	299
6	445.50	445.50	445.50	570.50	570.50	570.50	570.50	570.50	570.50	570.50	339
7	461.00	508.00	508.00	508.00	587.69	587.69	587.69	587.69	587.69	587.69	343
8	461.00	508.00	508.00	508.00	587.69	587.69	587.69	587.69	587.69	587.69	343
9 & 10	2,459.40	1,989.03	1,724.32	1,524.32	1,411.82	1,411.82	1,211.82	1,040.40	960.40	860.40	907
11&12	2,459.40	2,348.29	2,348.29	1,948.29	1,835.79	1,835.79	1,835.79	1,589.36	1,409.36	1,409.36	907
13&14	2,459.40	2,348.29	2,348.29	2,348.29	2,348.29	2,468.29	2,468.29	2,382.57	2,382.57	2,222.57	907
15&16	2,544.40	2,860.62	2,860.62	2,860.62	2,860.62	2,860.62	2,860.62	2,849.91	2,849.91	2,819.91	945
17	1,508.00	1,272.81	1,140.46	1,040.46	984.21	789.21	789.21	703.50	663.50	613.50	1112
18	1,508.00	1,458.00	1,458.00	1,258.00	1,258.00	1,063.00	963.00	963.00	873.00	873.00	1112
19	1,508.00	1,555.00	1,555.00	1,680.00	1,680.00	1,740.00	1,540.00	1,497.14	1,337.14	1,337.14	1112
20	1,560.40	1,607.40	1,607.40	1,607.40	1,607.40	1,607.40	1,607.40	1,607.40	1,607.40	1,607.40	1158

Table 15: Tank filling states during loading sequences

In Figure 24 it is observed that the final vertical displacement is higher than  $-6$  centimetres and in the Appendix section is seen that at the final loading sequence, the final filling state given by the designer was not reached. The reason is that even though the pre-loading moment was generated, it was not taken into account during the righting moment calculation. Therefore, since the vertical displacement was smaller than  $+/- 10$  centimetres, the load on the load cell remains within the limits established. Additionally, the final filling of the tanks might also be much closer to the one indicated by the designer.

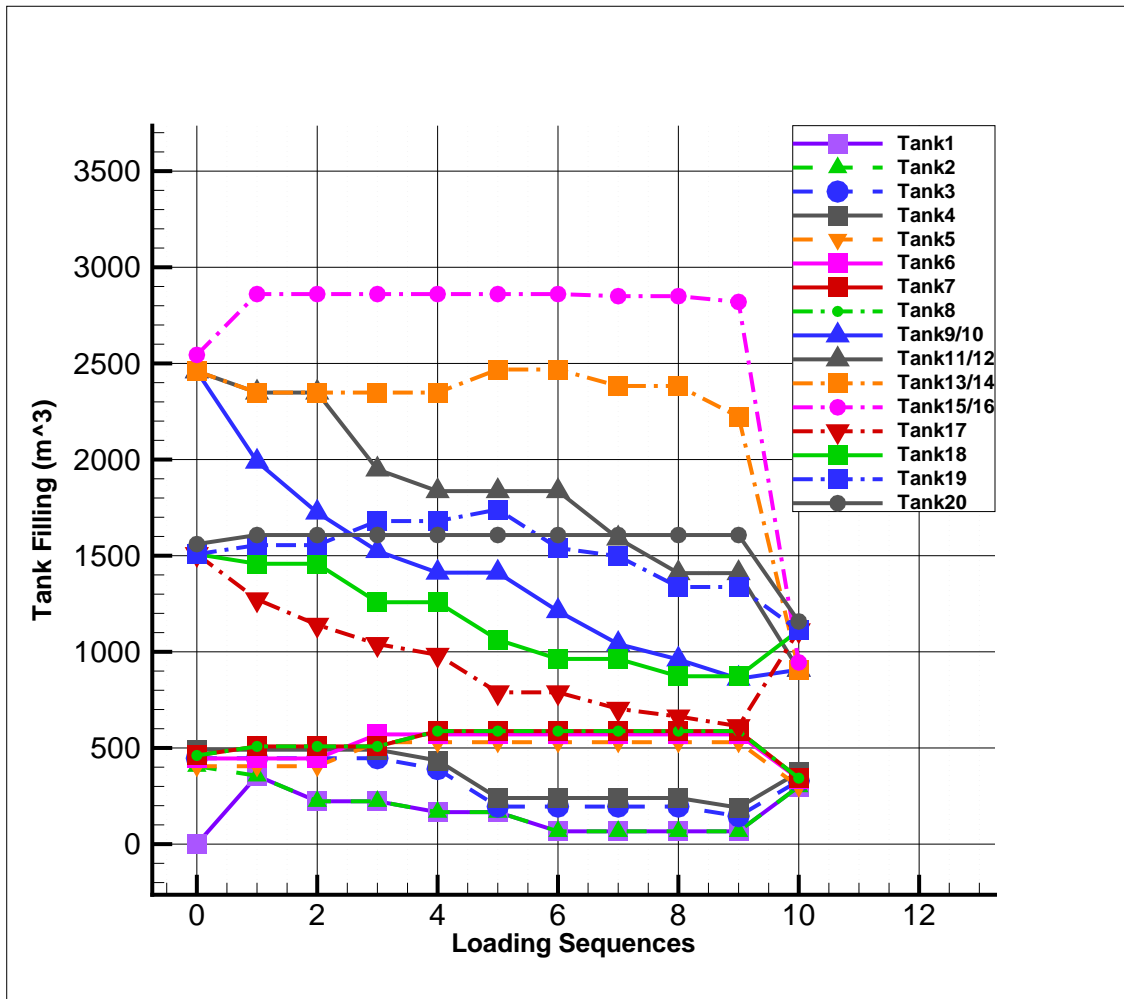

Figure 26: Tank water flow during loading sequences

## 5 ALGORITHM

As specified before in the problem description, the simulation involves the development of two algorithms. One to deploy the trolleys under the vessel and one to control the fill state of the dock's ballast tanks during the transfer process. In Figure 27 the simulation's general flowchart is drawn. The two sub-processes inside it, represent the two algorithms presented in this section.

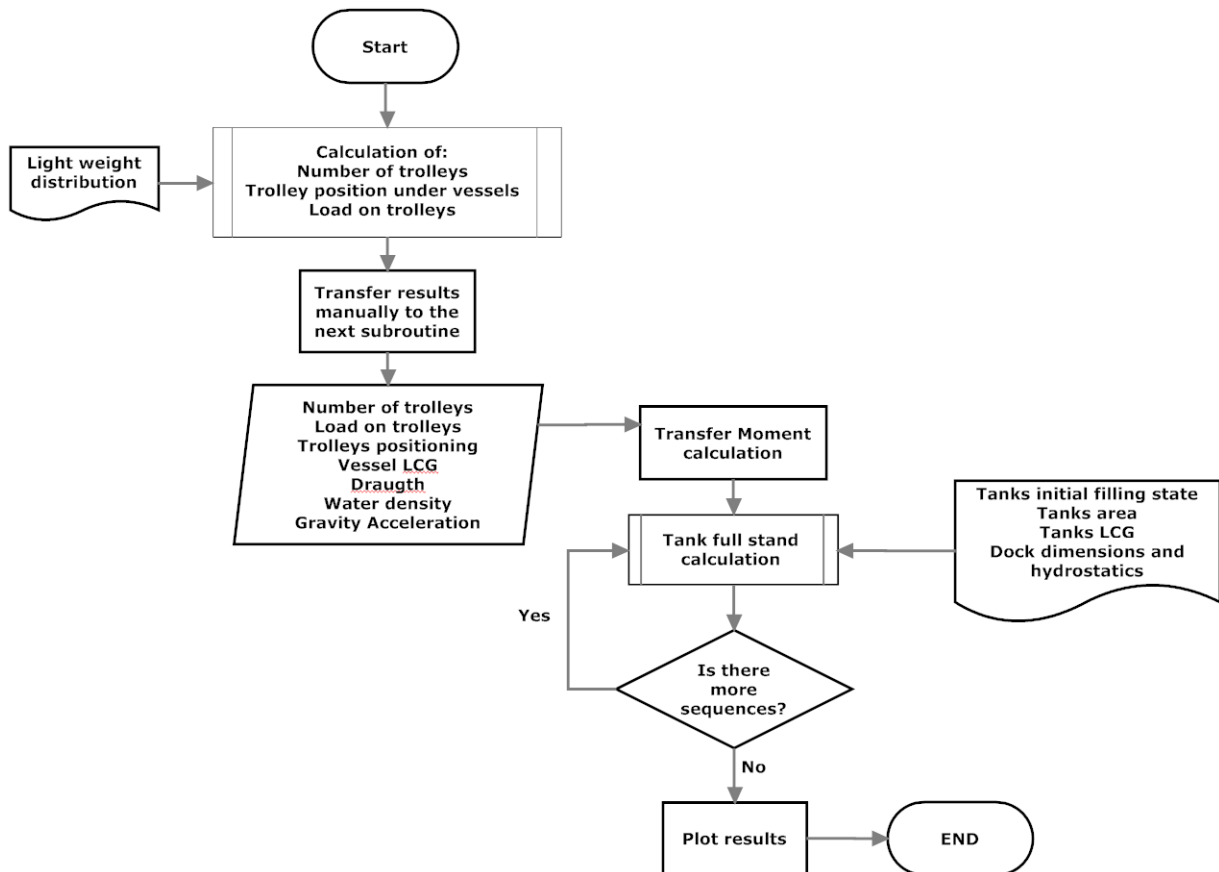

Figure 27: General flowchart of simulation

### 5.1 Trolley Placement

The number of trolleys required depend on the vessel's lightweight, the number of trolleys that can be placed under the vessel depend on the vessel's **LOA** but the position will depend directly on the lightweight distribution. This distribution is not uniform and a peak value is normally seen where the wheelhouse is positioned.

This lightweight distribution will be read from a *.tab* file, in this code it was named "light\_w2". This file is the only input required for the trolley positioning and it will contain the lightweight sectioned in equal parts. In addition, this first section from the code contains the definition of specified constant variables which restrain the weight capacity of the transfer ("ship\_wmax") and the trolleys ("trestle\_wmax"), which establish the possible distance between trolleys ("trestle\_dmax and trestle\_dmin") and the predefinition of some variables required further in the code for loops and conditionals.

```

clearall;
lw_dist = dlmread('light_w2.tab');
trestle_wmax = 650;
trestle_dmax = 9;
trestle_dmin = 4.5;
ship_wmax = 5000;
limit_tm = 2 * trestle_wmax / trestle_dmax;
k = 1;
p = 1;
b = 0;
c = 1;
p = 1;
q = 0;
z = 0;

```

Assuming a that the trestles have a symmetrical weight distribution, their weight was deducted from *trestle\_wmax*, furthermore its value was set to 650t instead of 673t. *q*, *z* and *limit\_tm* are constants which control the space between trolleys and determine if a space of 4.5 meters should be considered for calculations. Assuming a constant distribution as in Figure 28, the value of *limit\_tm* is equal to the theoretical maximum of tons per meter that two group of trolleys can bear together. *q* is used to validate the “if” conditional when *limit\_tm* has been exceed. If *z* changes from a “false” to a “true” state, the span between trolleys changes to *trestle\_dmin* and these are placed along the whole vessel.

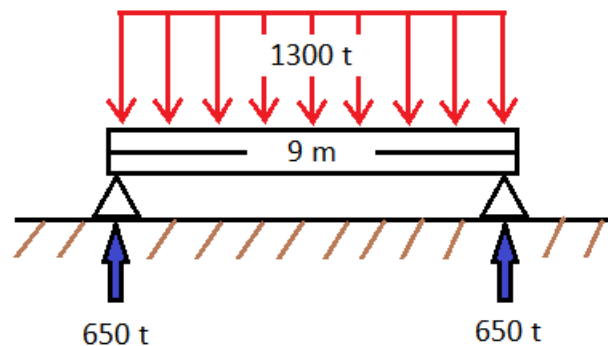

Figure 28: Free body diagram for *limit\_tm*

When reading the *.tab* file, the number of sections in which the lightweight has been divided and the span of each section is determined. These are denoted “*n*” and “*a*” respectively and it is assumed that the span will remain constant for the whole lightweight distribution.

Once *a* and *b* are determined, the next section of the code approximates the area of each section delimited by *a* with the Trapezoid Rule. These areas are saved into the matrix *lw* and are added together. The sum of the values in inside the matrix *lw* gives the approximate value of the vessel’s lightweight. If this value is bigger than 5000 tons, as shown in Figure 29, a warning error window will pop out indicating the failure and terminating the program.

```

n = length(lw_dist);
a = (lw_dist(n, 1) - lw_dist(1, 1)) / (n - 1);

```

```

for i = 1 : n - 1
    lw(i) = a * ((lw_dist(i, 2) + lw_dist(i + 1, 2))/2);
end

if sum(lw) > ship_wmax
    warndlg('Dock transfer capacity has been exceeded', 'Warning');
return;
end

```

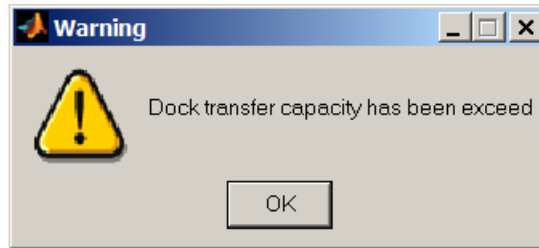

Figure 29: Warning message if capacity was exceed

The next step is to determine the number of trolleys necessary to transport the vessel. Because there is no unique solution to this question, the methodology to approach this problem was to define a maximum and a minimum number, any value within this delimited range is a potential “optimal” solution to the unknown.  $t_n$  is the number of trolleys that based on the trolleys weight capacity, are sufficient to carry the vessel.  $s_n$  is the theoretical number of trolleys that based on the vessel’s LOA, can be placed under the vessel.

```

t_n = ceil(sum(lw)/trestle_wmax);
s_n = ceil(lw_dist(n, 1)/trestle_dmax);

```

Generally the value of  $t_n$  will be smaller than  $s_n$ , but the situation where a vessel is relatively heavy when compared to its length might present. As a consequence of  $s_n$  being smaller than  $t_n$ , the value of  $s_n$  must be increased. Instead of dividing by the usual 9 m span between trolleys  $trestle_dmax$ , division by  $trestle_dmin$  will be carried out. The value of  $s_n$  will double. If the value of  $s_n$  is still smaller than  $t_n$  then not enough trolleys can be placed to sustain the vessel. Subsequently, a warning dialogue appears and the program is terminated. If not the case,  $z$  will become “true” and with a span of 4.5 m, the trolleys will then be placed at an initial position starting from zero and this position will be saved in the matrix  $t.start$ . The number of trolleys placed will go from  $t_n$  to  $s_n$ .

```

if t_n > s_n
    s_n = ceil(lw_dist(n, 1)/trestle_dmin);
    if t_n > s_n
        warndlg('The vessel is not long enough to place the required trolleys', 'Warning');
        return;
    else
        for j = 1 : abs(t_n - s_n) + 1
            for i = 1 : t_n + b
                t(j).start(i) = trestle_dmin * (i - 1);
            end
        end
    end
end

```

```

        end
        b = b + 1;
    end
    z = 1;
end
else
end

```

In the following part of the code a big conditional clause which controls the trolley positioning is started. It was mentioned before that the lightweight distribution is commonly not uniform, so it may occur that only at a section of the ship *limit\_tm* is exceeded. *M* finds the maximum value of the lightweight distribution and compares it with *limit\_tm*. The position along the ship of this maximum value *M* is found and saved at *mid\_k*.

The fact that the unit of *limit\_tm* is tons per meter, means that there is a level of uncertainty if wherever the total applied force at that section could be too much for only 2 trolleys to bear or not. Therefore, if *M* is bigger than *limit\_tm*, an additional trolley in between other two will be placed. The additional trolley will be placed in a “cascade” effect as shown in Figure 30 and 31 until *m\_k*. The objective of this cascade effect is to create more possible solutions than the already existent with just a span of 9*m*. These are saved in the *t.start2* structure array.

```

M = max(lw_dist(:, 2));
if (M > limit_tm) & (z == 0)
    for k = 1 : n
        if lw_dist(k, 2) == M
            m_k(p) = k;
            p = p + 1;
        else
        end
    end
end
mid_k = sum(m_k)/length(m_k);

```

Besides *mid\_k*, the cascade effect positioning depends on other two factors, *dis\_up* and *dis\_down*. These two constants represent the measured distance to the right and to the left of *mid\_k*. Their addition would represent the vessel’s LOA. The objective is to limit the cascade effect, if *dis\_down* is smaller than *dis\_up*, trolleys will be added from left to right as shown in Figure 30.

On the contrary, if *dis\_up* is smaller, trolleys will be added from right to left as in Figure 31. In both cases, *q* will change its value from 0 to the number of solutions contained in the structure array *t.start2*. For example in Figures 30 and 31 *q* would be equal to 2.

```

p = 1;
k = 2;
count = 0;

```

```

dis_down = ((lw_dist(ceil(mid_k), 1) - lw_dist(floor(mid_k), 1))/2) + ...
...lw_dist(floor(mid_k), 1);

```

```

dis_up = ((lw_dist(ceil(mid_k), 1) - lw_dist(floor(mid_k), 1))/2) + ...
...lw_dist(n, 1) - lw_dist(ceil(mid_k), 1);

```

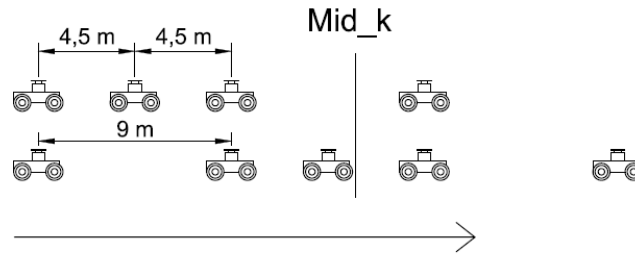

Figure 30: Cascade positioning from left to right

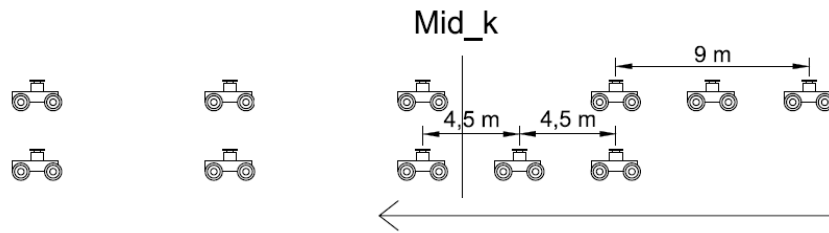

Figure 31: Cascade positioning from right to left

```

if dis_down < dis_up
    q = floor(dis_down/trestle_dmax);
    b = 1;
    for j = 1 : q
        for i = 1 : t_n + b
            if (count < q) & (k == i)
                t(j).start2(i) = t(j).start2(i - 1) + trestle_dmin;
                count = count + 1;
            elseif (count == 0) & (i > k)
                t(j).start2(i) = trestle_dmax * (i - 2);
            else
                t(j).start2(i) = trestle_dmax * (i - 1);
            end
        end
        b = b + 1;
        k = k + 1;
    end
else
    q = floor(dis_up/trestle_dmax);
    b = 0;
    for j = 1 : q
        count = 0;
        for i = 1 : s_n - b
            t(j).start2(i) = trestle_dmax * (i - 1 - count);
            if (i == s_n - b - 1)
                t(j).start2(i) = t(j).start2(i - 1) + trestle_dmin;
                count = 1;
            else

```

```

                end
            end
            b = b + 1;
        end
    end
    g = 1;
    b = 0;

```

The additional cascade solutions saved at *t.start2* will be combined with the structure array *t.start*. The solutions contained in *t.start* consider only a span of 9 *m* and trolleys are added progressively from *t.n* to *s.n*. In order to combine both structure arrays, the value of *q* is used to extend the loop. The output of the following loop is still *t.start* but containing the additional information.

```

    for j = 1 : abs(t.n - s.n) + 1 + q
        if j > abs(t.n - s.n) + 1
            t(j).start = t(g).start2;
            g = g + 1;
        else
            for i = 1 : t.n + b
                t(j).start(i) = trestle_dmax * (i - 1);
            end
            b = b + 1;
        end
    end
end

```

If the condition ( $M > limit_{tm}$ ) is not fulfilled and  $z = 0$ , therefore, without the need to calculate *mid\_k*, *dis\_up* and *dis\_down* to add more potential solutions, *t.start* is determined.

```

elseif z == 0;
    for j = 1 : abs(t.n - s.n) + 1
        for i = 1 : t.n + b
            t(j).start(i) = trestle_dmax * (i - 1);
        end
        b = b + 1;
    end
end
else
end

```

The structure array *t.start*, as the name implies, places the trolleys with a defined span in a starting position. From this position, the trolleys will be moved  $a/2$  meters until the trolley that is located further to the right reaches the end of the vessel.  $a/2$  has been taken instead of *a* to gain an increase in resolution and widen the search area.

All the movements will generate a new trolley positioning along the vessel whose values will be saved in the array of structures *t.line.pos*.

```

for j = t.n : s.n + q
    pos = t(j - t.n + 1).start;
    p = 1;
    while pos(length(t(j - t.n + 1).start)) < lw_dist(n, 1)

```



```

    for i = 1 : length(t(j - t_n + 1).start)
        pos(i) = pos(i) + (a/2);
    end
    t(j - t_n + 1).line(p).pos = pos;
    p = p + 1;
end
end
end

```

To determine the force exerted on the trolleys, the following static conditions were used:

$$\sum F_y = 0 \quad (41)$$

$$\sum M = 0 \quad (42)$$

The equations obtain from these two conditions can be grouped as:

$$\begin{bmatrix} 1 & 1 \\ x1 & x2 \end{bmatrix} = \begin{bmatrix} Ra \\ Rb \end{bmatrix} = \begin{bmatrix} F \\ M \end{bmatrix} \Rightarrow [A][X] = [B]$$

The final part of the program will generate matrices  $A$ , and  $B$  and solve for  $X$ . The method utilized to approach this solution is called the matrix inverse method. The inverse matrix  $A^{-1}$  of the coefficient matrix  $A$  must be computed, and the solution vector  $X$  will be defined by the product of  $A^{-1}$  times  $B$  as shown in the equation below.

$$[X] = [A^{-1}][B] \quad (43)$$

The loop in the next part of the code determines the coefficient matrix  $A$ .  $A$  consists of a row is made of ones which will have the same length as  $t.line.pos$  and of a row where the positions recorded at the structure array  $t.line.pos$  will be just transferred.  $A$  will be stored in  $t.line.A$ .

```

for j = 1 : abs(t_n - s_n) + 1 + q
    for i = 1 : length(t(j).line)
        t(j).line(i).A = vertcat(ones(1, length(t(j).line(i).pos)), t(j).line(i).pos);
    end
end
end

```

The vessels sustained by the trolleys can be represented as pinned supported free beam where a distributed force is being applied. The loop below calculates the point at which the statical equivalent force is being applied. This point is saved in the variable *centroid*. In this case, the magnitude of the equivalent force will be the area under the lightweight distribution curve or simply the vessel's lightweight. This value is saved in the constant *force*. When *centroid* and *force* have been determined, the coefficient matrix  $B$  is generated. The values inside  $B$  will remain constant when solving for  $X$  for every structure array in  $t.line.A$ .

```

for i = 1 : n - 1
    C(i) = ((a/2) + (i - 1)) * lw(i);
end
centroid = sum(C)/sum(lw);
force = sum(lw);

```

```
B = [force, force * centroid];
```

It can be seen that the system is statically indeterminate and it is no possible to invert the coefficient matrix  $A$  by the normal Matlab command *inv*. Therefore, the Moore-Penrose inverse has been utilized to calculate a pseudo-inverse. The pseudo-inverse is calculated by Matlab through the function *pinv* and the equations can be solve to obtain approximate solutions. All solutions are saved in the structure array *t.line.X*.

```
for j = 1 : abs(t_n - s_n) + 1 + q
    for p = 1 : length(t(j).line)
        t(j).line(p).X = pinv(t(j).line(p).A) * B';
    end
end
end
```

When the force exerted on the trolleys is calculated, it is necessary to filter them and take only the ones that may be “useful”. This is done with the combination of loops and conditionals below. The main conditions are the following:

- No force applied on the trolley can be smaller than 0.
- this one No reaction applied on the trolley can be bigger than *trestle\_wmax*.
- Only solutions that have a difference smaller than or equal to 10 tons between each trolley will be stored.

Solutions that fulfil this conditions are stored at the structure *sol*. *sol.X* saves the value of the forces applied in each trolley and *sol.post* their position. The structure array *sol* is the final output for the trolley placement algorithm.

```
for j = 1 : abs(t_n - s_n) + 1 + q
    for p = 1 : length(t(j).line)
        for i = 1 : length(t(j).line(p).X)
            if i == 1
                if (t(j).line(p).X(i) <= 0) | (t(j).line(p).X(length(t(j).line(p).X)) <= 0)
                    b = 1;
                elseif (t(j).line(p).X(i) > trestle_wmax)...
                    ... | (t(j).line(p).X(length(t(j).line(p).X)) > trestle_wmax)
                    b = 1;
                end
                elseif (abs(t(j).line(p).X(i) - t(j).line(p).X(i - 1)) <= 10) & (b = 1)
                    sol(c).X = t(j).line(p).X;
                    sol(c).pos = t(j).line(p).pos;
                    c = c + 1;
                    b = 1;
                else
                    end
            end
            b = 0;
        end
    end
end
end
```

## 5.2 Ballast tank planning

This program is based on the static analysis done previously in Section 4, the aim is to determine the concept of an algorithm that determines most of the variables by itself. Limits and restrictions had to be established for this to be possible. Results obtained from the first algorithm are a necessary input for the simulation to be generated. The first algorithm gives a list of the best possible solutions, the user must choose the option he considers as best suitable for the operation.

First all variables are demanded to the user or given by default. *trestle\_w* and *trolley\_w* consider the extra weight proportioned by the trestles and trolleys to the floating dock during the transfer. One trestle weights approximately 23 tons and one trolley 7 tons. *Troll width* defines the approximate total length of a transfer trolley whose value was obtained from its technical data sheet. *Shell* gives the value of the shell factor used in calculations. *Limit up* and *Limit down* are limits established for tank filing. The water level in tanks cannot be lower than 0.3 meters since empty tanks are not allowed. It was considered that this water level gives enough clearance to the pump. Furthermore, the water level shall not surpass 3 meters during the ballast tank planning. This limit intends to restrict the tanks so that solutions where tanks were completely filled are not reached.

The pre-loading force is defined in *preload* and a value of 800 tons was given. *transfer\_mom*, *mom* and *seq* are variables used further ahead in the program, they were set to 0 because they generate problems when the program is run continuously if their value is not reset.

```
clc;
trestle_w = 23;
trolley_w = 7;
troll_width = 2;
shell = 1.012;
limit_down = 0.3;
limit_up = 3;
preload = 800;
mom = 0;
transfer_mom = 0;
seq = 0;
```

The following part of the code reads information from 2 different files, *tank\_initial.tab* and *dock.info.tab*. *tank\_initial.tab* reads information related to the tanks.

The first document read is *tank\_initial.tab* and small part of the document is shown in Table 16. *range* is a variable used to delimit the reading file function *dlmread*. The matrix contains 4 values, the first two indicate the starting point while the last two the point to stop the reading. The cells and rows are counted starting from 0.

The initial filling state, the initial water level, the tanks LCG and the XY area are read from the file and save into the structure *tanks*.

```
range = [1, 1, 20, 1];
tanks.in_fill = dlmread('tank_initial.tab', 't', 1, 1, range);
range = [1, 2, 20, 2];
tanks.meter = dlmread('tank_initial.tab', 't', 1, 2, range);
range = [1, 3, 20, 3];
tanks.LCG = dlmread('tank_initial.tab', 't', 1, 3, range);
```

```
range = [1, 4, 20, 4];
tanks.area = dlmread('tank_initial.tab', '_t', 1, 4, range);
```

Tanks	M3	M	LCG	Area
1	405	2.46	-66.85	164.48
2	405.0	2.46	-66.85	164.48
3	446.5	2.25	-18.9	198.82

Table 16: tab\_initial.tab file example

Next *dock\_info.tab* is read and the dock LOA, breadth, displacement, moment to change trim and metacentric height are read and save into variables of the structure *b*.

```
range = [0, 1, 0, 1];
dock.l = dlmread('dock_info.tab', '_t', range);
range = [1, 1, 1, 1];
dock.b = dlmread('dock_info.tab', '_t', range);
range = [2, 1, 2, 1];
dock.d = dlmread('dock_info.tab', '_t', range);
range = [3, 1, 3, 1];
dock.MTC = dlmread('dock_info.tab', '_t', range);
range = [4, 1, 4, 1];
dock.GM = dlmread('dock_info.tab', '_t', range);
```

When the program is started, the user is asked wherever he wants to conserve all previous data. If *Y* is given, the data is saved but it can be still modified if desired. This option permits the user to rerun the program several times as required. If the program is being run for the first time, there is no previous data to save and an error will emerge. If *N* is answered, the program will reset all input values to the default ones.

```
data = questdlg('Do you want to erase all introduced data?', 'Warning', 'Y', 'N', 'Y');
```

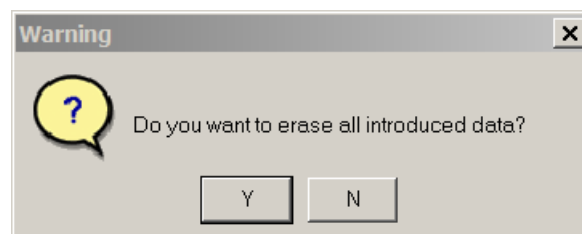

Figure 32: Question to erase all previous data

The user interface is shown at Figure 33. Seven variables are required as input, the number of trestles, the load per trestle, the trestle positioning along the vessel, the vessel's LCG, the dock draught, the water density and the gravity acceleration.

There are default input values given by the software. These values do not possess any particular

Figure 33: User interface for data input

significance and they are used as an example to input the data correctly.

```

prompt = {'Enter number of trestles :',' Enter loadper trestle (t) :',...
         'Trestle position along vessel : (bow to stern, m)',' Enter vessel LCG(m)',...
         'Enter dock draught (m)',' Enter water density : (t/m3)',...
         'Enter Gravity Acceleration (m/s2)'};
dlg_title = ' Dock Parameters';
num_lines = 1;
if strcmp(data,' N')
    def = answer1, answer2, answer3, answer4, answer5, answer6, answer7;
else
    def = '3',' 500, 500, 500',' 9, 9, 9',' 0, 0, 0',' 3.325',' 1.01',' 9.81';
end
answer = inputdlg(prompt,dlg_title,num_lines,def);

```

The input is recorded as a string value, therefore it requires to be transformed to a numerical integer so that it can be used during calculations. The transformed data is saved in the variables shown in the code section below.

```

t_n = str2num(answer1);
load = str2num(answer2);
tres_dis = str2num(answer3);
v_lcg = str2num(answer4);
draft = str2num(answer5);
p = str2num(answer6);
g = str2num(answer7);

```

The number of trestles and the number of characters in the load per trestle and position under the vessel input must be the same. If not there is a warning message display, as shown in Figure 34, and the program is terminated. The goal is to avoid input problems when the numbers are too high.

```
if ((t_n = length(load)) | (t_n = length(tres_dis)))
    warndlg('Number of trestles doesn't coincide with input', 'Warning');
    return;
end
```

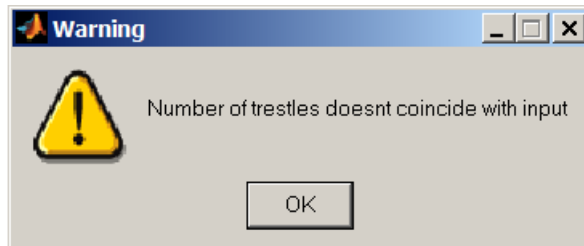

Figure 34: Warning for incorrect input

This part of the program takes the position of the trestles under the vessel, and determines the distance between them and stores it in the matrix variables *tres\_space*. The first distance between trestles is 0 by default. The remaining are determined subtracting between the position they had under the vessel. When the distance between trolleys is known, it is possible to determine the distance that the vessel must traverse until it is placed at the dock's LCG. The position of the last trestle under the vessel (from bow to stern), is subtracted from the vessel's LCG position and the residual is added to the docks LCG distance. This value is saved in the variable *dis\_trans*.

```
for i = 1 : length(tres_dis)
    if i == 1;
        tres_space(i) = 0;
    else
        tres_space(i) = tres_dis(i) - tres_dis(i - 1);
    end
end
dis_trans = (dock.l/2) + (tres_dis(length(tres_dis))) - v_lcg;
```

In the following section of the code, the matrix variable *load*, which contains the load applied at each trestle, is arranged so that it can be multiplied in correct order to obtain the moment generated per loading sequence. Furthermore the weight of the trestle and trolleys is added. This new arrangement and weight is saved in the structure array *T.load*.

The distance that each trolley advances per sequence is also required for moment calculation. Sequence number one always advances the same distance which is dependant from the trolley's width. The remaining sequences depend on the distance between trestles which was obtained previously. The distances are saved in the structure array *T.pos*. This matrix is vertically positioned due to matrix multiplication rules.

```
b = 1;
for j = 1 : length(load)
```

```

for i = 1 : b
    T(j).load(i) = load(length(load) - b + i) + trestle_w + (trolley_w * 2);
    if i == 1
        T(j).pos(i) = (dock.l/2) - (troll_width/2);
    else
        T(j).pos(i) = T(j).pos(i - 1) - tres_space(i);
    end
end
end
T(j).pos = T(j).pos';
b = b + 1;
end

```

The moment per sequence is calculated by multiplying the two structure arrays *T.pos* and *T.load*, the results are saved in the structure array *T.mom*.

```

b = 1;
for j = 1 : length(load)
    for i = 1 : b
        mom(i) = T(j).load(i) * T(j).pos(i);
    end
    T(j).mom = sum(mom);
    b = b + 1;
end

```

The next section of the code prepares the results obtained for plotting. The moment values for the first and last sequences are added since their value is theoretically 0. An example of the plot printed by the software is given in Figure 35. The information from the static analysis section was used for comparison.

```

for i = 1 : length(load) + 2
    if i == 1
        transfer_mom(i) = 0;
        seq(i) = 0;
    elseif i == length(load) + 2
        transfer_mom(i) = 0;
        seq(i) = length(load) + 1;
    else
        transfer_mom(i) = T(i - 1).mom;
        seq(i) = i - 1;
    end
end
end
plot(seq, transfer_mom, '-square', 'LineWidth', 2, 'MarkerFaceColor', 'b');
grid on

```

It was observed that at the beginning and at the end of a transfer process, ballast tanks need to have approximately the same level of water. The quantity of water to remove is theoretically the same as the one applied on the floating dock. As consequence, the displacement and the draught remains constant, and only the tank water level is altered. This change in level can be

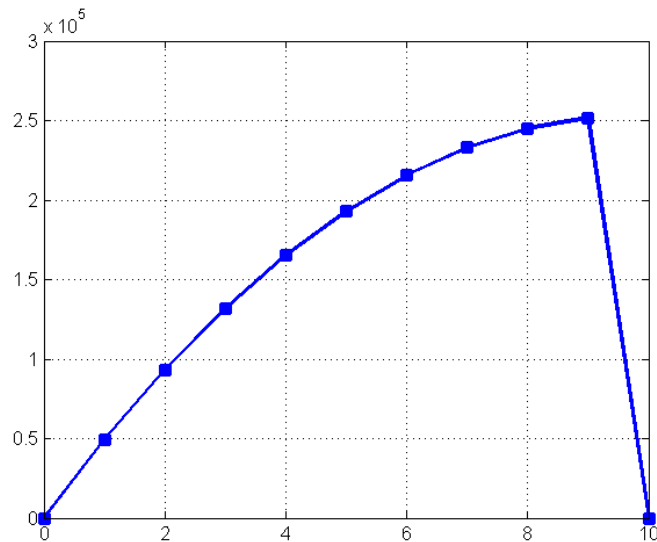

Figure 35: Transfer moment plotted by algorithm

approximated as a change of draught in the floating dock. Therefore, the change of draught is calculated and saved into the variable *new\_lvl*, this difference in level is multiplied by the XY area of the tank and the volume of water to be removed per tank is obtained. The calculated volume is saved into the structure array *tanks.sub\_vol* and subtracted from the initial filling state. The resultant volume is the volume to reach when the transfer is over. The final volume is saved in the substructure array *tanks.f\_fill*.

```
water_out = sum(T(length(load)).load);
new_lvl = abs(draft - ((dock.d - water_out)/(dock.l * dock.b * shell)));
tanks.sub_vol = tanks.area * new_lvl;
tanks.f_fill = tanks.in_fill - tanks.sub_vol;
```

The code below calculates the average level of water from the substructure array *tanks.f\_fill*. This average level will be used as reference to know how full or empty the tanks cards when comparing to the target level.

Utilizing the information from the static analysis section, a final average water level of 1.8 m is obtained. This value is close to the average level of 1.78 given by the designer.

```
for i = 1 : length(tanks.area)
    height(i) = tanks.f_fill(i)/tanks.area(i);
end
aveh = sum(height)/length(tanks.area);
```

In order to further restrict the algorithm, a superior and inferior limits were established before, *limit\_down* and *limit\_up*. The following part of the program calculates the water volume limits per tank.

```
for i = 1 : length(tanks.area)
    tanks.limit_filldown(i) = tanks.area(i) * limit_down;
    tanks.limit_fillup(i) = tanks.area(i) * limit_up; end
```



It was decided to standardize the pre-loading sequence since it reduces complexity to the problem. The pre-loading configuration used during the static analysis was implemented. A fixed volume of  $100 m^3$  is removed or added from the selected tanks. The disadvantage of this setting is that if a problem with any tank emerges, the pre-loading phase would need to be adjusted manually before the process starts by the user.

```
preload_mom = (dock.l/2) * 800; tanks.in_fill(1) = tanks.in_fill(1) - 100;
tanks.in_fill(9) = tanks.in_fill(1) - 100;
tanks.in_fill(10) = tanks.in_fill(1) - 100;
tanks.in_fill(17) = tanks.in_fill(1) - 100;
tanks.in_fill(2) = tanks.in_fill(1) - 100;
tanks.in_fill(18) = tanks.in_fill(1) - 100;
tanks.in_fill(7) = tanks.in_fill(1) + 100;
tanks.in_fill(19) = tanks.in_fill(1) + 100;
tanks.in_fill(8) = tanks.in_fill(1) + 100;
tanks.in_fill(15) = tanks.in_fill(1) + 100;
tanks.in_fill(16) = tanks.in_fill(1) + 100;
tanks.in_fill(20) = tanks.in_fill(1) + 100;
```

This next part reads the document *tank\_combi.tab*. This file contains four group of combinations of tanks that won't provoke heeling is the same amount of water is taken from them. Each group is related to a pump. Also at in one column, the number of tanks at each combination is given. An example of this document is shown in Table 17.

```
range = [0, 5, 27, 5];
tanks.combi = dlmread('tank_combi.tab', '_t', range);
```

	1	2			2	
	1	2	17		3	
	17				1	
Pump 1	9	10			2	
	9	10	17		3	
	1	2	9	10	4	
	1	2	9	10	17	5
	3	4			2	
	11	12			2	
	18				1	
Pump 1	3	4	18		3	
	11	12	18		3	
	3	4	11	12	4	
	3	4	11	12	18	5

Table 17: Part of the *tank\_combi.tab* document

Finally, the concept for the ballast tank generator is shown below. This last part of the code is delimited to work the first sequence of the transfer. The distance travelled is calculated and stored in the variable *dis*. Next, all variables required for the cycles are defined *a*, *h* and *z*. In total there are four cycles present, the most outer one, which uses the variable *j* to count represents the speed, the following one, where *i* is implemented as a counter, represents the pump capacity. The value is expressed in  $m^3/min$  since:

$$3000 \frac{m^3}{h} = 50 \frac{m^3}{min} \quad (44)$$

The value goes from -50 to 50, therefore pumping water in and out is considered. The next cycle inside, where the variable *k* is implemented, is responsible for considering all tank combinations during the calculations.

The last cycle is responsible of selecting the tank combinations and applying the speed and pump configurations from the outer cycles to determine, the volume of water that can be removed or added, calculate the moment and subtract this volume to *tanks.in\_fill*. The result is saved in the sub-substructure array *new\_fill*. If *new\_fill* becomes bigger or smaller than the limits *limit\_up* or *limit\_down* established at the beginning of the algorithm, one of the inner cycles is broken and it jumps to the following one in the count.

This last part of the code requires approximately 4 minutes to run, it generates 40,400 calculations to determine the moment of all combinations defined in *tank\_combi.tab*. The next part would have been to filter taking into consideration the possibility of adding between combinations. All solutions which compensate the transfer moment were to be saved. The one with the least change in trim and draft would be selected as the combination that would favour best the first sequence of the transfer. Calculation of all sequences would required an additional outer cycle and a very high computational time.

```

dis = (dock.l/2) - T(1).pos(1); a = 1;
h = 1;
z = 1;
forj = 0.1 : 0.1 : 2
    m = j/dis
    time = dis^2/((m * dis^2) + dis)
    fori = -50 : 1 : 50
        fork = 1 : length(tanks.combi)
            combo = tanks.combi(k);
            forp = 1 : length(combo)
                speed(a).pump(h).tank(z) = time * i/(length(combo));
                speed(a).pump(h).mom(z) = tanks.LCG(combo(p)) * ...
                speed(a).pump(h).tank(z);

speed(a).pump(h).new_tank(z) = (tanks.in_fill(combo(p))spe + ...
    speed(a).pump(h).tank(z))/tanks.area(combo(p));
    if((speed(a).pump(h).new_tank(z) < limit_down)...
    |(speed(a).pump(h).new_tank(z) > limit_up))
        break;
    else

```

```
        end
      end
      z = z + 1;
    end
    h = h + 1;
  end
  a = a + 1;
end
```

## 6 CONCLUSION

Floating dock operations are complex processes that require time, planning and excellent knowledge of floating bodies and stability. All operations related to floating docks, require the removal or addition of water from its ballast tanks. If a vessel is docked or launched, the vessel's shape, structural arrangement, hull shape, light weight distribution and the vessel's current heel and trim must be given to the dock master. He must correctly set the block arrangement or docking plan that will support the vessel. Analysis of floating bodies requires time, since many factors need to be considered and many cases need to be assumed in order to have a complete understanding of a phenomenon.

During all operations, the dock master must actively receive all possible feedback from the dock to plan every sequence during dock operations. Advances in technology have permitted to control this process remotely.

Transfer operations involve the coordination of a transferring system with the ballast system, the speed of the transfer system and the pump capacity of the ballast system are the key values which determine the capacity of the process. To automatize this type of processes it is essential to have clear understanding of what is required to monitor and to control. Components have to be carefully and the control architecture has to be thought so the system can react in all possible scenarios. Automatized floating docks must have reversible pumps since gravity filling cannot have a constant volumetric flow and control over tank water levels becomes far complex.

Tools like algorithms to create software can be developed to make this type of static analysis simpler. These type of tools are hard to develop because they can be developed in different ways and they must contain all variables necessary for calculations. Furthermore, these variables need to be classified in the ones known and the ones unknown but required. Other complexity is that the market always develop. Clients requirements and needs change fast. Hence, the obligation to develop always further without stopping is existent. If done correctly algorithms have big advantages. They can repeat the same type of analysis an unlimited amount of times in a reduced time span. This contributes greatly to the process time reduction. Additionally, algorithms created with an structured logic can be recreated in other software which uses a different type of writing language.

Regarding future work for this master thesis, both algorithms presented here must be joined into one. So there must be development of the code to transfer data from one code to the other. Input data and documents need to be closer to what is used in real simulation software on-board.

## **Acknowledgements**

First, I would like to thank Stefan Winkler, manager of the Flume tanks division from Hoppe Marine, for his support and contributions given for my master thesis. Also my thanks to Hoppe Marine, for allowing to feel part of the team and for their kind threat towards me.

Secondly, I would also like to thank Prof. Bronsart for his good organization in Germany, classes started on schedule and the professor were the best. I would also thank his interest towards our interests, development and confort during our stay in Rostock.

Thirdly, I would like to thank Prof. Rigo for allowing me to take part of this program and his quick support whenever it was required during the organization of the whole master program.

Lastly, I would like to thank my parents, who gave me the opportunity, give me the support inspiration and trust, and to whom I have been thankful ever since the day I was born. To able to participate and complete this master program is all thanks to them.

This thesis was developed in the frame of the European Master Course in “Integrated Advanced Ship Design” named “EMSHIP” for “European Education in Advanced Ship Design”, Ref.: 159652-1-2009-1-BE-ERA MUNDUS-EMMC.

## 7 APPENDIX

The objective of this section is to familiarize the reader with the excel program used for the static analysis. As explained before the static analysis was divided into eleven loading sequences but for this excel program one more was added between loading sequence 9 and 10, where the first trolley is positioned exactly at the floating dock's LCG.

This case was added with the intention to observe if the behaviour was linear as predicted from the loading sequence 9, when the moment is maximum, to the loading sequence 10, when it becomes zero. In the excel program the sequences are labelled as cases.

It can be perceived that the tanks are organized and coloured in accordance to the pump-tank configuration proposed in Figure 16.

Loading sequence 0 has a smaller configuration since it only involves the pre-loading of the floating dock. In this analysis, 800 tons of water were chosen as pre-loading force and they are equivalent to:

$$Pre - loading\ moment = 800 \times \frac{L_{dock}}{2} = 67340\ t.m \quad (45)$$

The real moment applied was 69073 t.m and a change in draft of 0.11 centimetres was provoked. This change is considered in the next loading sequence.

In all other remaining cases, tanks are first selected in the *on/off* column, 1 stands for selected and 0 for not selected. *out/in* is used to select the working pump capacity for the current loading sequence. The *-/+* stands for removing or adding water respectively. The chosen capacity is divided equally between all selected tanks. This divided capacity is shown in the column *Pump Cap. per Tank*.

The *Water pumped* column uses the time equation derived in Section 4, to calculate the time elapsed between the current and the precedent, consequently, the quantity of water obtained with the selected capacity is calculated.

*Water in tank* shows the quantity of water of the precedent sequence while the *Remaining water in tank* contains the value of the subtraction between the *Water pumped* and *Water in tank* columns. Once the water pumped or removed has been determined, the righting moment per tank is calculated in the *Upright moment* column. The addition of the moment generated by all tanks is placed at the *Righting moment* cell which is located at the table on the right part of the sheet. The righting moment must be approximately equal to the *Transfer moment* of the current loading section.

The *t.m/min* column is used to determine the how much momentum is being applied by minute by the tanks in the ballast system. This is used as double check since the addition of the column must also be approximately equal to the *transfer moment* cell with *t.m/min* units which is located in the table at the right.

The *tank state* column shows how much water volume is above or under the final filling tank volume. Green represents water above and red water under. A value close or equal to 0 at the final sequence signifies that the tank has the correct filling volume.

The speed input is located at the top and is coloured in blue. The speed given by the user is that which the trolleys would have reached at current loading sequence.

At the table located to the right,  $\Delta Trim$  and  $\Delta Draft$  represent the current change of trim and draft at the current sequence. *Total trim* and *Total draft* represent the addition of changes of trim and draft of all precedent sequences until the current sequence. The values of *Total draft* and *Total trim* are the plotted below the table.

Lastly, the *time* cell gives the value of the time between the precedent and current sequence, while the *total time* cell gives the addition of all precedent sequences until the current one. This cells where used as an indicator when reducing the over all time needed for the transfer operation.

Loading Case		0	PRELOAD	
Tank #	Water Pumped (m <sup>3</sup> )	Water in tank (m <sup>3</sup> )	Remaining water in tank (m <sup>3</sup> )	Upright moment
1	-100.00	405.00	305.00	6,751.85
3	0.00	446.50	446.50	0.00
9,10	-200.00	2,459.40	2,259.40	12,726.00
17	-100.00	1,508.00	1,408.00	6,363.00
2	-100.00	405.00	305.00	6,751.85
4	0.00	491.00	491.00	0.00
11,12	0.00	2,459.40	2,459.40	0.00
18	-100.00	1,508.00	1,408.00	2,121.00
5	0.00	405.00	405.00	0.00
7	100.00	461.00	561.00	6,575.10
13,14	0.00	2459.40	2,459.40	0.00
19	100.00	1508.00	1,608.00	2,121.00
6	0.00	445.50	445.50	0.00
8	100.00	461.00	561.00	6,575.10
15,16	200.00	2544.40	2,744.40	12,726.00
20	100.00	1560.40	1,660.40	6,363.00

Pre-load force required	800 t
Pre-load moment required	67340 t.m
Pre-load moment applied	69073.90 t.m
Pre-load force applied	820.6 t
Change in draft	0.11 cm

Table 18: Pre-loading specifications

Loading Case 1			Speed 0.180 m/min		Remaining water in tank (m <sup>3</sup> )		Upright moment (t.m)		Tank state		Transfer moment		Righting moment		Δ Trim		Δ draft		Time														
Tank #	on/off	Out/In	Pump Cap. Per Tank (m <sup>3</sup> /s)	Water Pumped (m <sup>3</sup> )	Water in tank (m <sup>3</sup> )	Remaining water in tank (m <sup>3</sup> )	Upright moment (t.m)	t.m/min	Tank state	Transfer moment	t.m	Transfer moment	t.m/min	Righting moment	t.m	Δ Transfer moment	t.m/min	Δ Trim	cm	Total trim	cm	Δ draft	cm	Total draft	cm	Time	min	Total time	min				
1	0		0.00	0.00	305.00	305.00	0.00	0.00	9.00	49285.8083	t.m	4435.7228	t.m/min	49490.00	t.m	18.38	t.m/min	0.19	cm	0.19	cm	-0.26	cm	-0.16	cm	11.11	min	11.11	min				
3	0		0.00	0.00	446.50	446.50	0.00	0.00	120.80																								
9,10	1		-0.56	-370.37	2,259.40	1,889.03	23,566.67	2,121.00	93.03																								
17	1	-3000	-0.28	-185.19	1,408.00	1,222.81	11,783.33	1,060.50	121.81																								
2	0		0.00	0.00	305.00	305.00	0.00	0.00	9.00																								
4	0		0.00	0.00	491.00	491.00	0.00	0.00	120.70																								
11,12	1		-0.17	-111.11	2,459.40	2,348.29	2,356.67	212.10	552.29																								
18	0	-600	0.00	0.00	1,408.00	1,408.00	0.00	0.00	307.00																								
5	0		0.00	0.00	405.00	405.00	0.00	0.00	109.00																								
7	0		0.00	0.00	561.00	561.00	0.00	0.00	221.40																								
13,14	1		-0.17	-111.11	2,459.40	2,348.29	-2,356.67	-212.10	552.29																								
19	0	-600	0.00	0.00	1,608.00	1,608.00	0.00	0.00	507.00																								
6	0		0.00	0.00	445.50	445.50	0.00	0.00	109.50																								
8	0		0.00	0.00	561.00	561.00	0.00	0.00	221.40																								
15,16	1		0.33	222.22	2,744.40	2,966.62	14,140.00	1,272.60	1095.42																								
20	0	1200	0.00	0.00	1,660.40	1,660.40	0.00	0.00	513.90																								
			Σ water tons		-561.11		Σ t.m/min (pump)	4,454.10																									

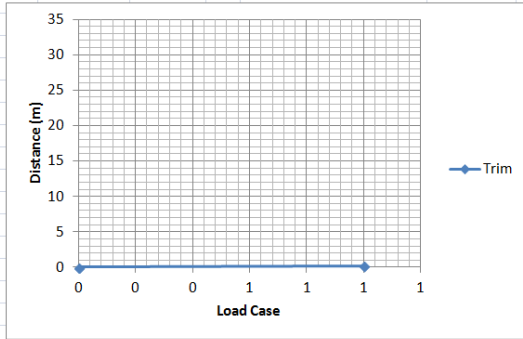
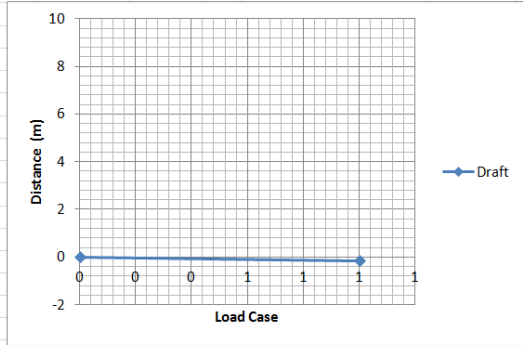
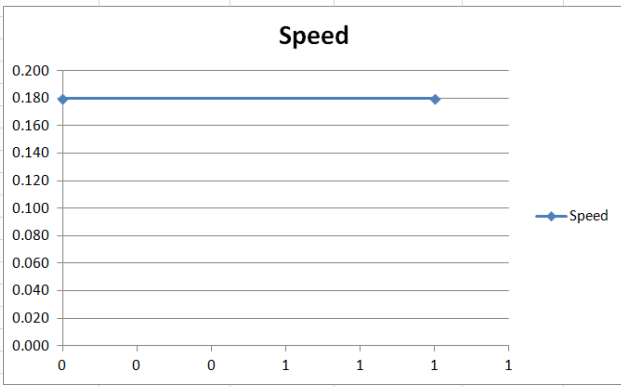
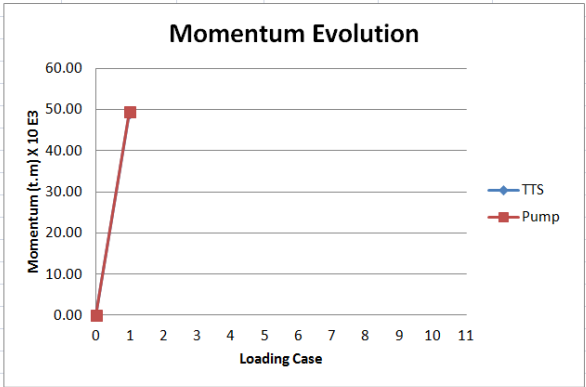



Loading Case 2			Speed 0.50 m/min													
Tank #	on/off	Out/In	Pump Cap. Per Tank (m <sup>3</sup> /s)	Water Pumped (m <sup>3</sup> )	Water in tank (m <sup>3</sup> )	Remaining water in tank (m <sup>3</sup> )	Upright moment (t.m)	t.m/min	Tank state							
1	1	1	-0.08	-132.35	305.00	172.65	8,936.27	337.59	-123.35	Transfer moment	93,238.62	t.m	Transfer moment	879.05617	t.m/min	
3	0	0	0.00	0.00	446.50	446.50	0.00	0.00	120.80	Righting moment	92,627.40	t.m	Δ Transfer moment	-750.58	t.m/min	
9,10	1	1	-0.17	-264.71	1,889.03	1,624.32	16,843.24	636.30	-171.68	Δ Trim	-0.56	cm	Total trim	-0.37	cm	
17	1	-1200	-0.08	-132.35	1,222.81	1,090.46	8,421.62	318.15	-10.54	Δ draft	1.00	cm	Total draft	0.84	cm	
2	1	1	-0.08	-132.35	305.00	172.65	8,936.27	337.59	-123.35	Time	26.47	min	Total time	37.58	min	
4	0	0	0.00	0.00	491.00	491.00	0.00	0.00	120.70							
11,12	0	0	0.00	0.00	2,348.29	2,348.29	0.00	0.00	552.29							
18	0	-300	0.00	0.00	1,408.00	1,408.00	0.00	0.00	307.00							
5	0	0	0.00	0.00	405.00	405.00	0.00	0.00	109.00							
7	0	0	0.00	0.00	561.00	561.00	0.00	0.00	221.40							
13,14	1	1	0.00	0.00	2,348.29	2,348.29	0.00	0.00	552.29							
19	1	0	0.00	0.00	1,608.00	1,608.00	0.00	0.00	507.00							
6	0	0	0.00	0.00	445.50	445.50	0.00	0.00	109.50							
8	0	0	0.00	0.00	561.00	561.00	0.00	0.00	221.40							
15,16	0	0	0.00	0.00	2,966.62	2,966.62	0.00	0.00	1095.42							
20	0	0	0.00	0.00	1,660.40	1,660.40	0.00	0.00	513.90							
Σ water tons				-668.38			Σ t.m/min (pump)	1,629.64								

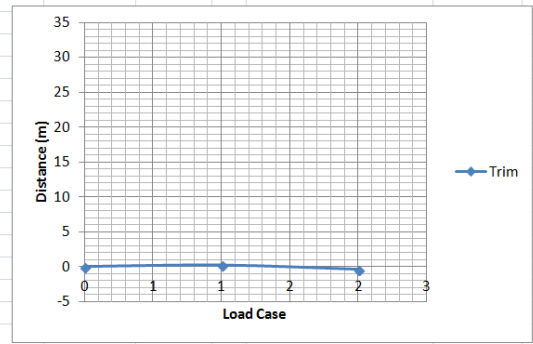
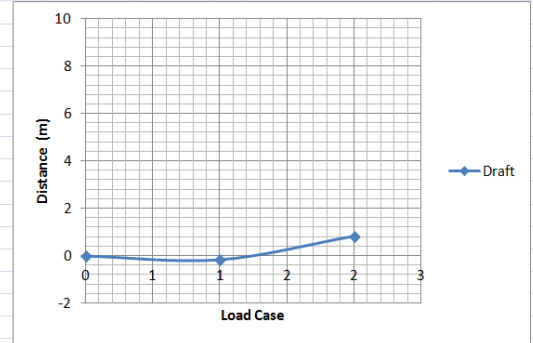
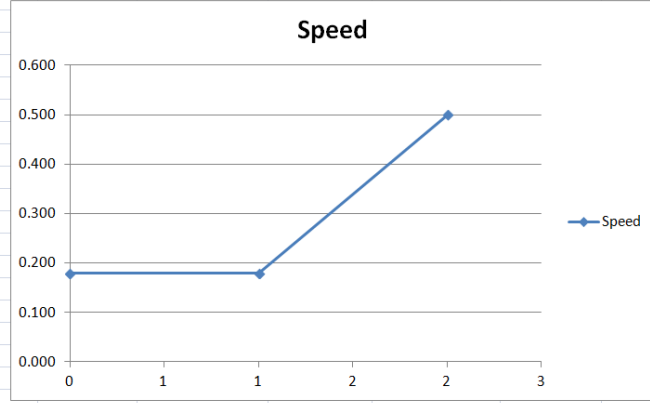
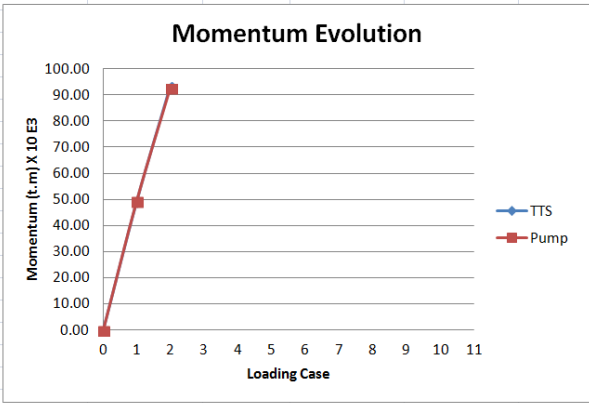

Loading Case 3			Speed 0.70 m/min		Remaining water in tank (m <sup>3</sup> )		Upright moment (t.m)		Tank state							
Tank #	on/off	Out/In	Pump Cap. Per Tank (m <sup>3</sup> /s)	Water Pumped (m <sup>3</sup> )	Water in tank (m <sup>3</sup> )	Remaining water in tank (m <sup>3</sup> )	Upright moment (t.m)	t.m/min								
1	0	0	0.00	0.00	172.65	172.65	0.00	0.00	-123.35	Transfer moment	131,858.43	t.m	Transfer moment	2574.6539	t.m/min	
3	0	0	0.00	0.00	446.50	446.50	0.00	0.00	120.80	Righting moment	131,424.02	t.m	Δ Transfer moment	-11.79	t.m/min	
9,10	1	1	-0.22	-200.00	1,624.32	1,424.32	12,726.00	848.40	-371.68	Δ Trim	-0.40	cm	Total trim	-0.77	cm	
17	1	-1200	-0.11	-100.00	1,090.46	990.46	6,363.00	424.20	-110.54	Δ draft	-0.63	cm	Total draft	0.21	cm	
2	0	0	0.00	0.00	172.65	172.65	0.00	0.00	-123.35	Time	15.00	min	Total time	52.58	min	
4	0	0	0.00	0.00	491.00	491.00	0.00	0.00	120.70							
11,12	1	1	-0.44	-400.00	2,348.29	1,948.29	8,484.00	565.60	152.29							
18	1	-2400	-0.22	-200.00	1,408.00	1,208.00	4,242.00	282.80	107.00							
5	1	1	0.14	125.00	405.00	530.00	2,165.19	144.35	234.00							
7	0	0	0.00	0.00	561.00	561.00	0.00	0.00	221.40							
13,14	0	0	0.00	0.00	2,348.29	2,348.29	0.00	0.00	552.29							
19	1	1000	0.14	125.00	1,608.00	1,733.00	2,651.25	176.75	632.00							
6	1	1	0.14	125.00	445.50	570.50	2,165.19	144.35	234.50							
8	0	0	0.00	0.00	561.00	561.00	0.00	0.00	221.40							
15,16	0	0	0.00	0.00	2,966.62	2,966.62	0.00	0.00	1095.42							
20	0	500	0.00	0.00	1,660.40	1,660.40	0.00	0.00	513.90							
			Σ water tons	-530.25			Σ t.m/min (pump)	2,586.44								

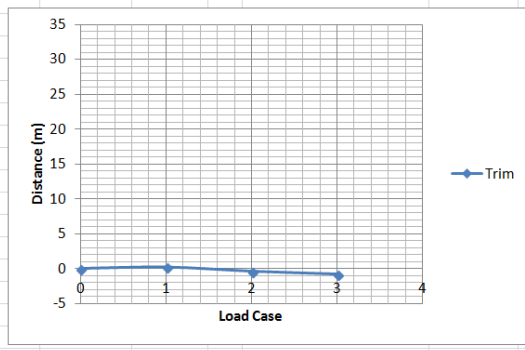
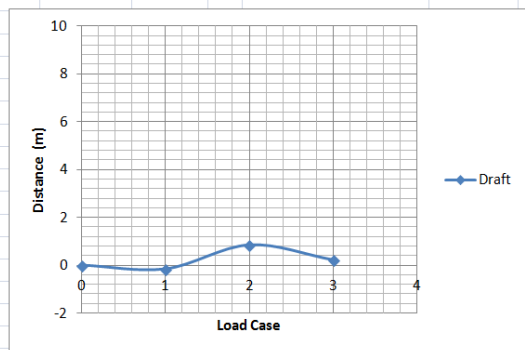
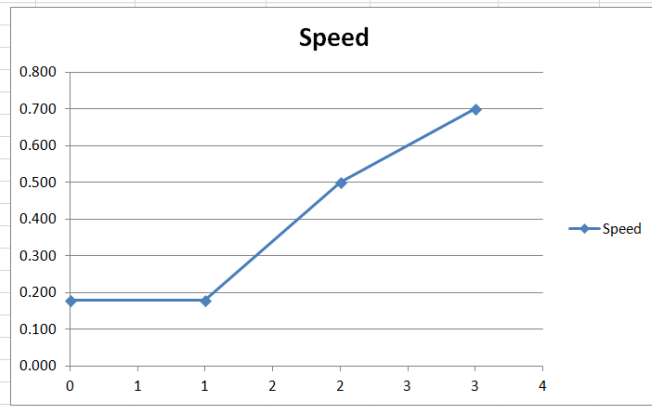
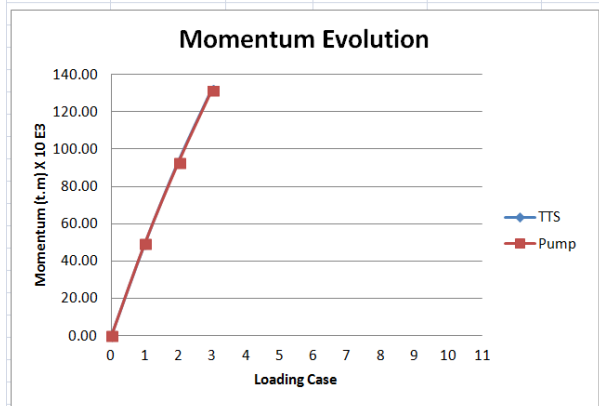

Loading Case			Speed		0.90 m/min											
Tank #	on/off	Out/In	Pump Cap. Per Tank (m <sup>3</sup> /s)	Water Pumped (m <sup>3</sup> )	Water in tank (m <sup>3</sup> )	Remaining water in tank (m <sup>3</sup> )	Upright moment (t.m)	t.m/min	Tank state							
1	1	1	-0.08	-56.25	172.65	116.40	3,797.92	337.59	-179.60	Transfer moment	165,145.23	t.m	Transfer moment	2958.8274	t.m/min	
3	1	1	-0.08	-56.25	446.50	390.25	1,073.76	95.45	64.55	Righting moment	164,770.12	t.m	Δ Transfer moment	-5.27	t.m/min	
9,10	1	1	-0.17	-112.50	1,424.32	1,311.82	7,158.38	636.30	-484.18	Δ Trim	-0.34	cm	Total trim	-1.12	cm	
17	1	-1500	-0.08	-56.25	990.46	934.21	3,579.19	318.15	-166.79	Δ draft	-2.74	cm	Total draft	-2.52	cm	
2	1	1	-0.08	-56.25	172.65	116.40	3,797.92	337.59	-179.60	Time	11.25	min	Total time	63.83	min	
4	1	1	-0.08	-56.25	491.00	434.75	1,073.76	95.45	64.45							
11,12	1	1	-0.17	-112.50	1,948.29	1,835.79	2,386.13	212.10	39.79							
18	0	-1200	0.00	0.00	1,208.00	1,208.00	0.00	0.00	107.00							
5	0	425	0.00	0.00	530.00	530.00	0.00	0.00	234.00							
7	1	1	0.12	79.69	561.00	640.69	5,239.53	465.74	301.09							
13,14	0	0	0.00	0.00	2,348.29	2,348.29	0.00	0.00	552.29							
19	0	0	0.00	0.00	1,733.00	1,733.00	0.00	0.00	632.00							
6	0	0	0.00	0.00	570.50	570.50	0.00	0.00	234.50							
8	1	1	0.12	79.69	561.00	640.69	5,239.53	465.74	301.09							
15,16	0	0	0.00	0.00	2,966.62	2,966.62	0.00	0.00	1095.42							
20	0	425	0.00	0.00	1,660.40	1,660.40	0.00	0.00	513.90							
Σ water tons				-350.34			Σ t.m/min (pump)	2,964.10								

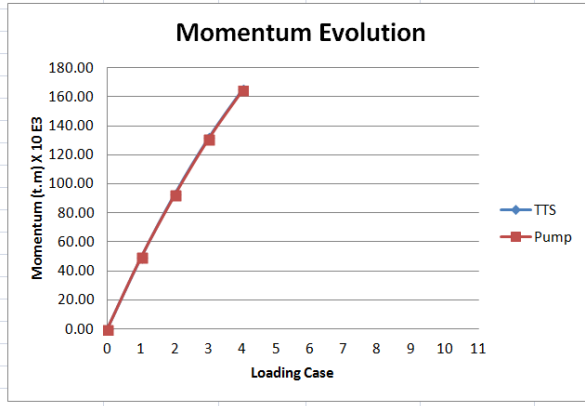
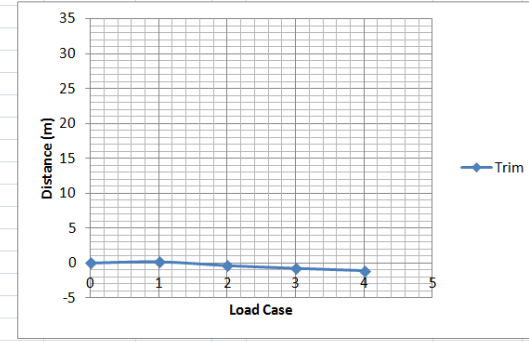
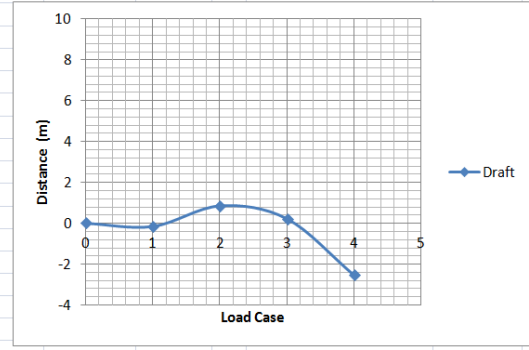

Loading Case			Speed		1.10 m/min											
Tank #	on/off	Out/In	Pump Cap. Per Tank (m <sup>3</sup> /s)	Water Pumped (m <sup>3</sup> )	Water in tank (m <sup>3</sup> )	Remaining water in tank (m <sup>3</sup> )	Upright moment (t.m)	t.m/min	Tank state							
1	0		0.00	0.00	116.40	116.40	0.00	0.00	-179.60	Transfer moment	193,099.04	t.m	Transfer moment	3105.9787	t.m/min	
3	1		-0.36	-195.00	390.25	195.25	3,722.36	413.60	-130.45	Righting moment	192,576.43	t.m	Δ Transfer moment	16.39	t.m/min	
9,10	0		0.00	0.00	1,311.82	1,311.82	0.00	0.00	-484.18	Δ Trim	-0.48	cm	Total trim	-1.60	cm	
17	1	-2600	-0.36	-195.00	934.21	739.21	12,407.85	1,378.65	-361.79	Δ draft	0.26	cm	Total draft	-2.26	cm	
2	0		0.00	0.00	116.40	116.40	0.00	0.00	-179.60	Time	9.00	min	Total time	72.83	min	
4	1		-0.36	-195.00	434.75	239.75	3,722.36	413.60	-130.55							
11,12	0		0.00	0.00	1,835.79	1,835.79	0.00	0.00	39.79							
18	1	-2600	-0.36	-195.00	1,208.00	1,013.00	4,135.95	459.55	-88.00							
5	0		0.00	0.00	530.00	530.00	0.00	0.00	234.00							
7	0		0.00	0.00	640.69	640.69	0.00	0.00	301.09							
13,14	1		0.22	120.00	2,348.29	2,468.29	2,545.20	282.80	672.29							
19	1	1200	0.11	60.00	1,733.00	1,793.00	1,272.60	141.40	692.00							
6	0		0.00	0.00	570.50	570.50	0.00	0.00	234.50							
8	0		0.00	0.00	640.69	640.69	0.00	0.00	301.09							
15,16	0		0.00	0.00	2,966.62	2,966.62	0.00	0.00	1095.42							
20	0	0	0.00	0.00	1,660.40	1,660.40	0.00	0.00	513.90							
Σ water tons					-606.00			Σ t.m/min (pump)	3,089.59							

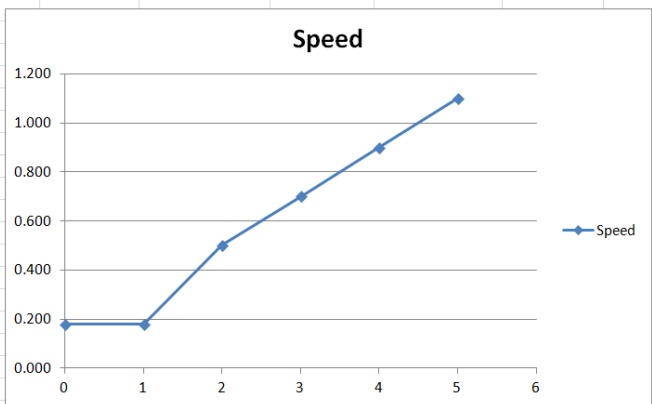
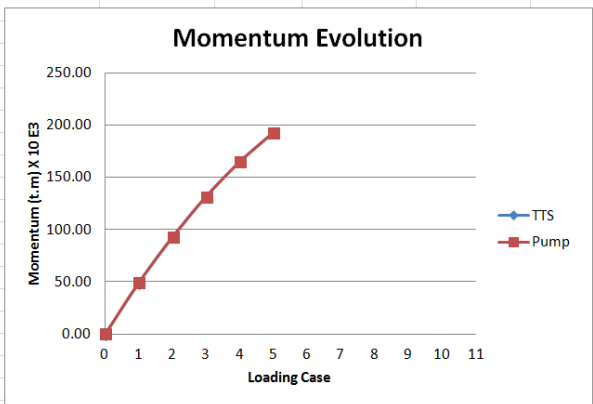
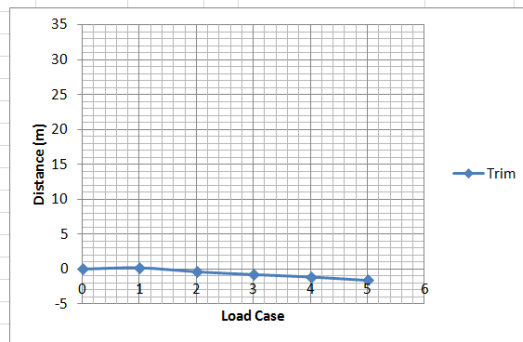
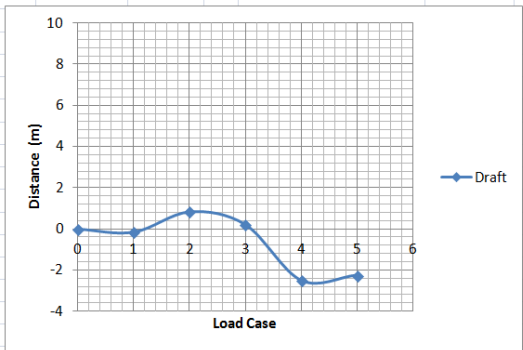

Loading Case			Speed		1.30 m/min											
Tank #	on/off	Out/In	Pump Cap. Per Tank (m <sup>3</sup> /s)	Water Pumped (m <sup>3</sup> )	Water in tank (m <sup>3</sup> )	Remaining water in tank (m <sup>3</sup> )	Upright moment (t.m)	t.m/min	Tank state							
1	1	1	-0.14	-62.50	116.40	53.90	4,219.91	562.65	-242.10	Transfer moment	215,719.85	t.m	Transfer moment	3016.1078	t.m/min	
3	0	0	0.00	0.00	195.25	195.25	0.00	0.00	-130.45	Righting moment	216,658.62	t.m	Δ Transfer moment	-194.85	t.m/min	
9,10	1	1	-0.28	-125.00	1,311.82	1,186.82	7,953.75	1,060.50	-609.18	Δ Trim	0.86	cm	Total trim	-0.74	cm	
17	0	-1500	0.00	0.00	739.21	739.21	0.00	0.00	-361.79	Δ draft	-0.77	cm	Total draft	-3.03	cm	
2	1	1	-0.14	-62.50	116.40	53.90	4,219.91	562.65	-242.10	Time	7.50	min	Total time	80.33	min	
4	0	0	0.00	0.00	239.75	239.75	0.00	0.00	-130.55							
11,12	1	1	-0.28	-125.00	1,835.79	1,710.79	2,651.25	353.50	-85.21							
18	1	-2000	-0.14	-62.50	1,013.00	950.50	1,325.63	176.75	-150.50							
5	0	0	0.00	0.00	530.00	530.00	0.00	0.00	234.00							
7	0	0	0.00	0.00	640.69	640.69	0.00	0.00	301.09							
13,14	0	0	0.00	0.00	2,468.29	2,468.29	0.00	0.00	672.29							
19	1	-1600	-0.44	-200.00	1,793.00	1,593.00	-4,242.00	-565.60	492.00							
6	0	0	0.00	0.00	570.50	570.50	0.00	0.00	234.50							
8	0	0	0.00	0.00	640.69	640.69	0.00	0.00	301.09							
15,16	0	0	0.00	0.00	2,966.62	2,966.62	0.00	0.00	1095.42							
20	1	1000	0.28	125.00	1,660.40	1,785.40	7,953.75	1,060.50	638.90							
Σ water tons				-517.63	Σ t.m/min (pump)				3,210.96							

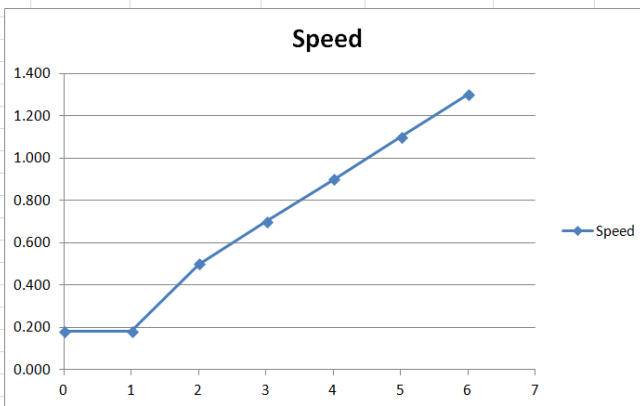
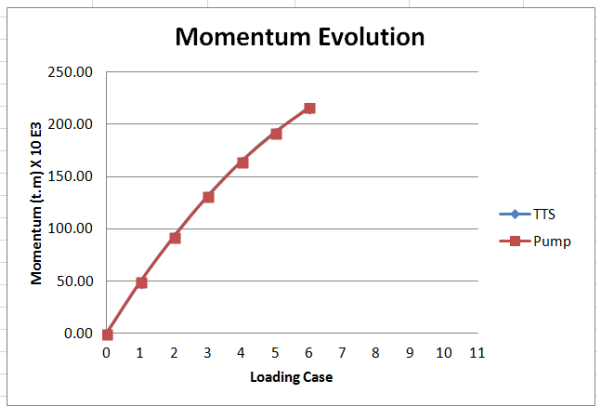
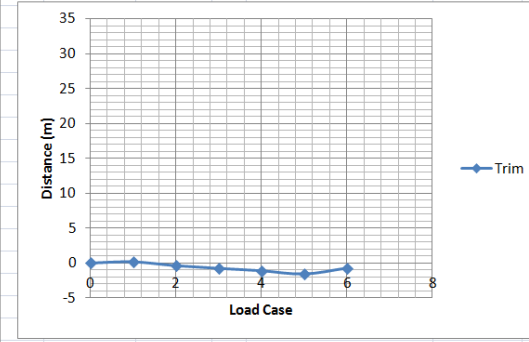
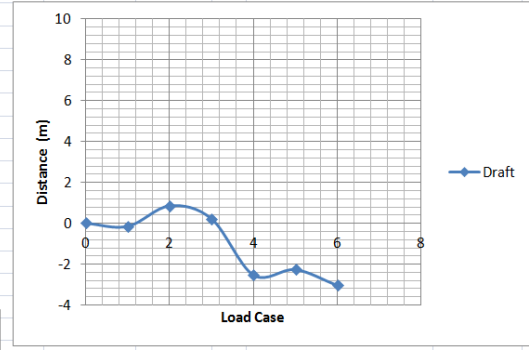

Loading Case 7			Speed 1.50 m/min		Remaining water in tank (m <sup>3</sup> )		Upright moment (t.m)		t.m/min		Tank state		Transfer moment		Righting moment		Δ Trim		Δ draft		Time	
Tank #	on/off	Out/In	Pump Cap. Per Tank (m <sup>3</sup> /s)	Water Pumped (m <sup>3</sup> )	Water in tank (m <sup>3</sup> )	Remaining water in tank (m <sup>3</sup> )	Upright moment (t.m)	t.m/min	Tank state	Transfer moment	t.m	Transfer moment	t.m/min	Δ Transfer moment	Total trim	cm	Total draft	cm	Total time	min		
1	0		0.00	0.00	53.90	53.90	0.00	0.00	-242.10	233,007.66	233,007.66	2689.2146	73.31	-0.31	-2.01	6.43	86.76					
3	0		0.00	0.00	195.25	195.25	0.00	0.00	-130.45	233,475.12	233,475.12	73.31	73.31	-0.31	-2.01	6.43	86.76					
9,10	1		-0.44	-171.43	1,186.82	1,015.40	10,908.00	1,696.80	-780.60	0.43	0.43	-0.31	-0.31	-0.31	-2.01	6.43	86.76					
17	1	-2400	-0.22	-85.71	739.21	653.50	5,454.00	848.40	-447.50	1.03	1.03	-2.01	-2.01	-2.01	-2.01	6.43	86.76					
2	0		0.00	0.00	53.90	53.90	0.00	0.00	-242.10	6.43	6.43	86.76	86.76	-0.31	-2.01	6.43	86.76					
4	0		0.00	0.00	239.75	239.75	0.00	0.00	-130.55													
11,12	1		-0.64	-246.43	1,710.79	1,464.36	5,226.75	813.05	-331.64													
18	0	-2300	0.00	0.00	950.50	950.50	0.00	0.00	-150.50													
5	0		0.00	0.00	530.00	530.00	0.00	0.00	234.00													
7	0		0.00	0.00	640.69	640.69	0.00	0.00	301.09													
13,14	1		-0.22	-85.71	2,468.29	2,382.57	-1,818.00	-282.80	586.57													
19	1	-1200	-0.11	-42.86	1,593.00	1,550.14	-909.00	-141.40	449.14													
6	0		0.00	0.00	570.50	570.50	0.00	0.00	234.50													
8	0		0.00	0.00	640.69	640.69	0.00	0.00	301.09													
15,16	1		-0.08	-32.14	2,966.62	2,934.48	-2,045.25	-318.15	1063.28													
20	0	-300	0.00	0.00	1,785.40	1,785.40	0.00	0.00	638.90													
Σ water tons				-670.93			Σ t.m/min (pump)	2,615.90														

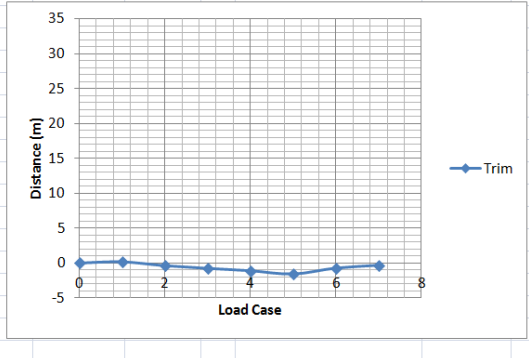
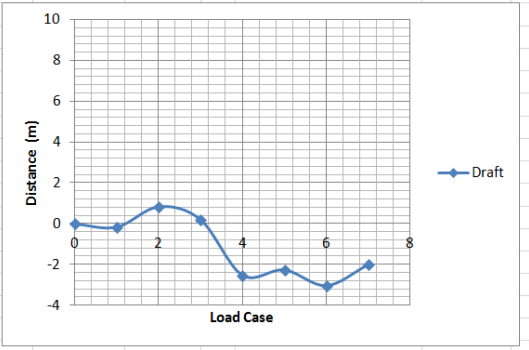
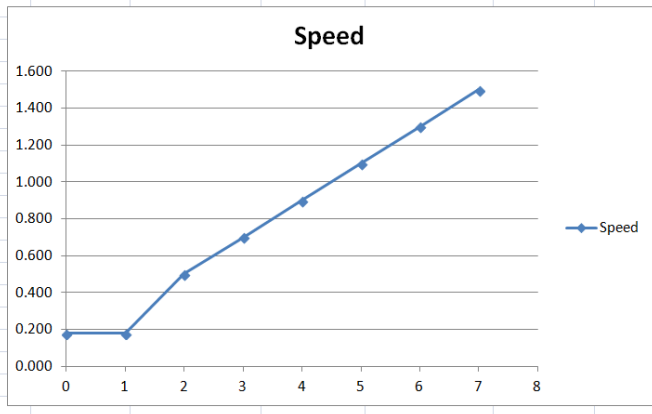
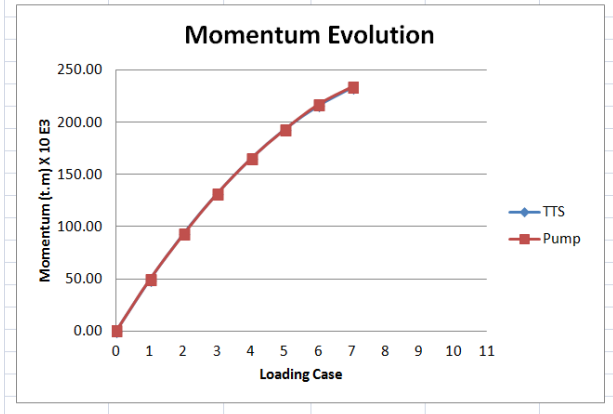

Loading Case			Speed		1.50 m/min											
Tank #	on/off	Out/In	Pump Cap. Per Tank (m <sup>3</sup> /s)	Water Pumped (m <sup>3</sup> )	Water in tank (m <sup>3</sup> )	Remaining water in tank (m <sup>3</sup> )	Upright moment (t.m)	t.m/min	Tank state							
1	0		0.00	0.00	53.90	53.90	0.00	0.00	-242.10	Transfer moment	244,962.47	t.m	Transfer moment	1992.4681	t.m/min	
3	0		0.00	0.00	195.25	195.25	0.00	0.00	-130.45	Righting moment	243,443.82	t.m	Δ Transfer moment	331.02	t.m/min	
9,10	1		-0.22	-80.00	1,015.40	935.40	5,090.40	848.40	-860.60	Δ Trim	-1.40	cm	Total trim	-1.70	cm	
17	1	-1200	-0.11	-40.00	653.50	613.50	2,545.20	424.20	-487.50	Δ draft	-0.33	cm	Total draft	-2.33	cm	
2	0		0.00	0.00	53.90	53.90	0.00	0.00	-242.10	Time	6.00	min	Total time	92.76	min	
4	0		0.00	0.00	239.75	239.75	0.00	0.00	-130.55							
11,12	1		-0.50	-180.00	1,464.36	1,284.36	3,817.80	636.30	-511.64							
18	1	-2700	-0.25	-90.00	950.50	860.50	1,908.90	318.15	-240.50							
5	0		0.00	0.00	530.00	530.00	0.00	0.00	234.00							
7	0		0.00	0.00	640.69	640.69	0.00	0.00	301.09							
13,14	0		0.00	0.00	2,382.57	2,382.57	0.00	0.00	586.57							
19	1	-1600	-0.44	-160.00	1,550.14	1,390.14	-3,393.60	-565.60	289.14							
6	0		0.00	0.00	570.50	570.50	0.00	0.00	234.50							
8	0		0.00	0.00	640.69	640.69	0.00	0.00	301.09							
15,16	0		0.00	0.00	2,934.48	2,934.48	0.00	0.00	1063.28							
20	0	0	0.00	0.00	1,785.40	1,785.40	0.00	0.00	638.90							
Σ water tons				-555.50			Σ t.m/min (pump)	1,661.45								

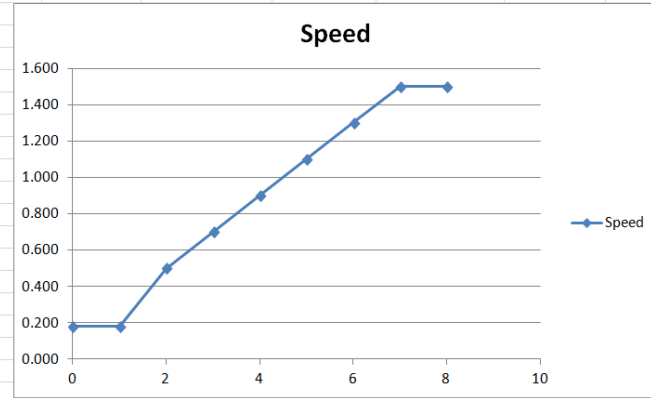
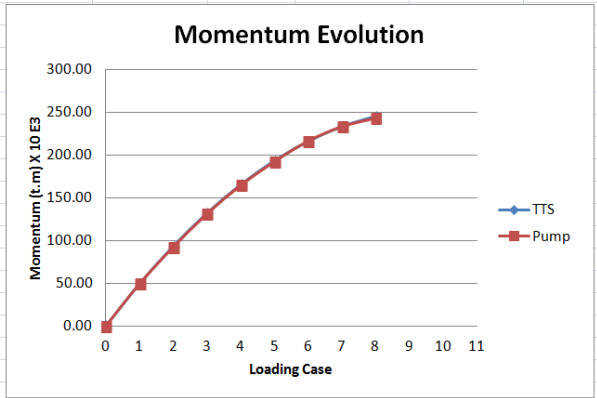
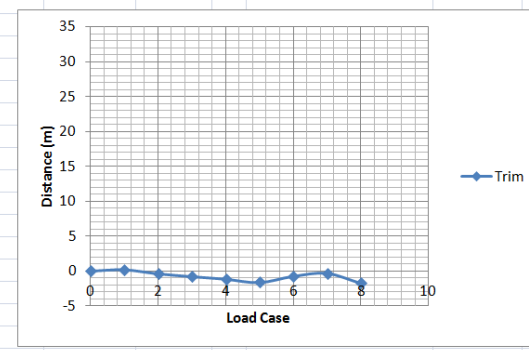
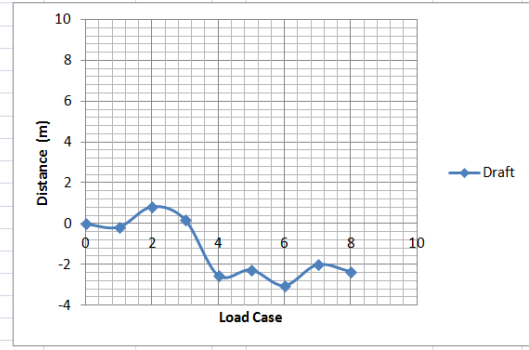

Loading Case 9			Speed 1.50 m/min		Remaining water in tank (m <sup>3</sup> )		Upright moment (t.m)		t.m/min		Tank state		Transfer moment		Righting moment		Δ Trim		Δ draft		Time												
Tank #	on/off	Out/In	Pump Cap. Per Tank (m <sup>3</sup> /s)	Water Pumped (m <sup>3</sup> )	Water in tank (m <sup>3</sup> )	Remaining water in tank (m <sup>3</sup> )	Upright moment (t.m)	t.m/min	Tank state	Transfer moment	t.m	Transfer moment	t.m/min	Δ Transfer moment	-112.41	t.m/min	Δ Trim	-0.78	cm	Total trim	-2.48	cm	Total draft	-3.67	cm	Time	6.00	min	Total time	98.76	min		
1	0		0.00	0.00	53.90	53.90	0.00	0.00	-242.10	251,584.28	t.m	1103.6347	t.m/min																				
3	1		-0.15	-55.00	195.25	140.25	1,049.90	174.98	-185.45	250,740.06	t.m																						
9,10	1		-0.31	-110.00	935.40	825.40	6,999.30	1,166.55	-970.60																								
17	1	-2200	-0.15	-55.00	613.50	558.50	3,499.65	583.28	-542.50																								
2	0		0.00	0.00	53.90	53.90	0.00	0.00	-242.10																								
4	1		-0.15	-55.00	239.75	184.75	1,049.90	174.98	-185.55																								
11,12	0		0.00	0.00	1,284.36	1,284.36	0.00	0.00	-511.64																								
18	0	-550	0.00	0.00	860.50	860.50	0.00	0.00	-240.50																								
5	0		0.00	0.00	530.00	530.00	0.00	0.00	234.00																								
7	0		0.00	0.00	640.69	640.69	0.00	0.00	301.09																								
13,14	1		-0.44	-160.00	2,382.57	2,222.57	-3,393.60	-565.60	426.57																								
19	0	-1600	0.00	0.00	1,390.14	1,390.14	0.00	0.00	289.14																								
6	0		0.00	0.00	570.50	570.50	0.00	0.00	234.50																								
8	0		0.00	0.00	640.69	640.69	0.00	0.00	301.09																								
15,16	1		-0.08	-30.00	2,934.48	2,904.48	-1,908.90	-318.15	1033.28																								
20	0	-300	0.00	0.00	1,785.40	1,785.40	0.00	0.00	638.90																								
Σ water tons				-469.65			Σ t.m/min (pump)	1,216.04																									

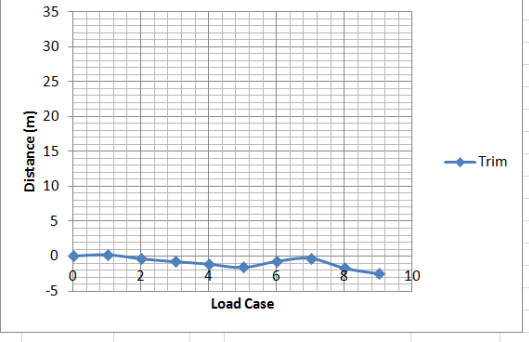
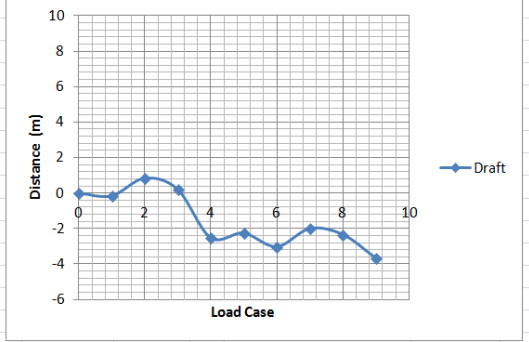
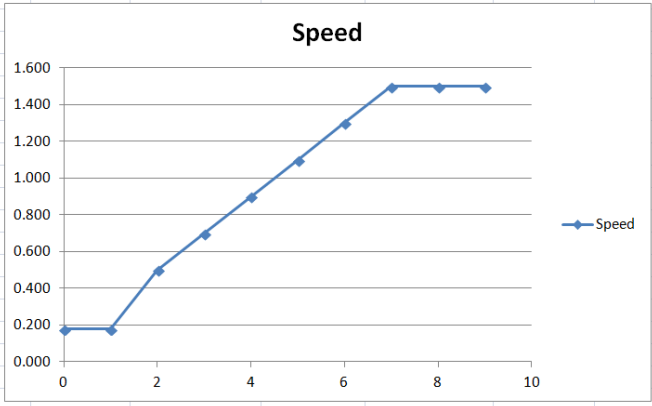
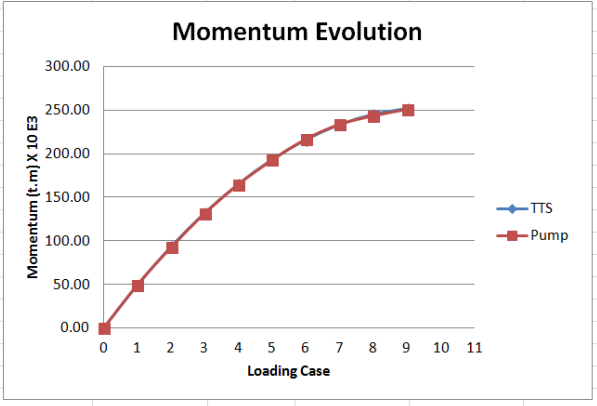



Loading Case 10			Speed 1.50 m/min		Remaining water in tank (m <sup>3</sup> )		Upright moment (t.m)		Tank state							
Tank #	on/off	Out/In	Pump Cap. Per Tank (m <sup>3</sup> /s)	Water Pumped (m <sup>3</sup> )	Water in tank (m <sup>3</sup> )	Remaining water in tank (m <sup>3</sup> )	Upright moment (t.m)	t.m/min								
1	0		0.00	0.00	53.90	53.90	0.00	0.00		-242.10	Transfer moment	170,656.00	t.m	Transfer moment	-10862.856	t.m/min
3	0		0.00	0.00	140.25	140.25	0.00	0.00		-185.45	Righting moment	171,732.81	t.m	Δ Transfer moment	-257.86	t.m/min
9,10	1		0.93	413.89	825.40	1,239.28	-26,335.75	-3,535.00		-556.72	Δ Trim	0.99	cm	Total trim	-1.49	cm
17	1	5000	0.46	206.94	558.50	765.44	-13,167.88	-1,767.50		-335.56	Δ draft	0.11	cm	Total draft	-3.57	cm
2	0		0.00	0.00	53.90	53.90	0.00	0.00		-242.10	Time	7.45	min	Total time	106.21	min
4	0		0.00	0.00	184.75	184.75	0.00	0.00		-185.55						
11,12	0		0.00	0.00	1,284.36	1,284.36	0.00	0.00		-511.64						
18	0	0	0.00	0.00	860.50	860.50	0.00	0.00		-240.50						
5	0		0.00	0.00	530.00	530.00	0.00	0.00		234.00						
7	0		0.00	0.00	640.69	640.69	0.00	0.00		301.09						
13,14	0		0.00	0.00	2,222.57	2,222.57	0.00	0.00		426.57						
19	0	0	0.00	0.00	1,390.14	1,390.14	0.00	0.00		289.14						
6	0		0.00	0.00	570.50	570.50	0.00	0.00		234.00						
8	0		0.00	0.00	640.69	640.69	0.00	0.00		301.09						
15,16	1		-0.93	-413.89	2,904.48	2,490.59	-26,335.75	-3,535.00		619.39						
20	1	-5000	-0.46	-206.94	1,785.40	1,578.46	-13,167.88	-1,767.50		431.96						
Σ water tons				0.00			Σ t.m/min (pump)	-10,605.00								

Transfer moment	170,656.00	t.m	Transfer moment	-10862.856	t.m/min
Righting moment	171,732.81	t.m	Δ Transfer moment	-257.86	t.m/min
Δ Trim	0.99	cm	Total trim	-1.49	cm
Δ draft	0.11	cm	Total draft	-3.57	cm
Time	7.45	min	Total time	106.21	min

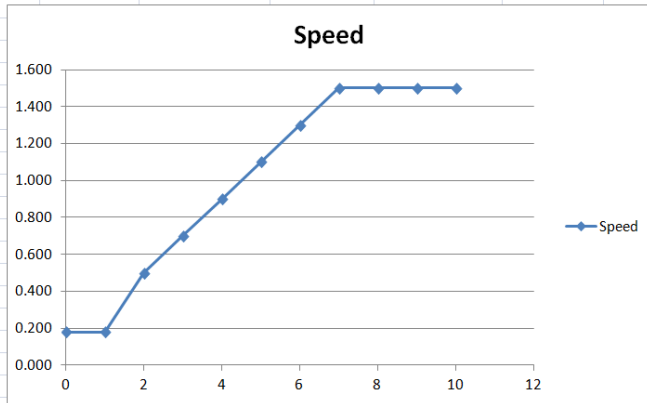
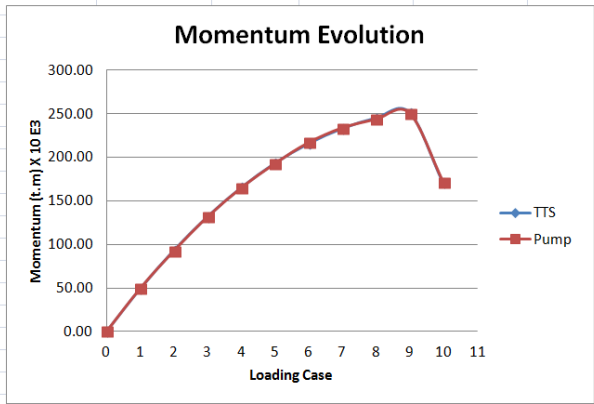
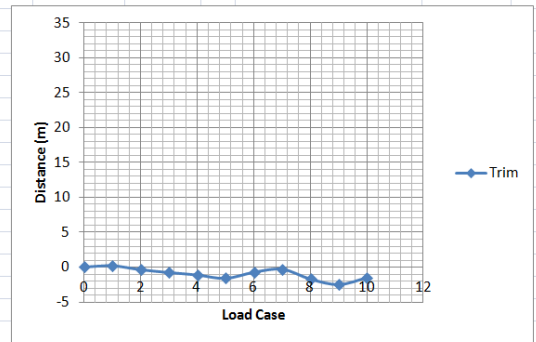
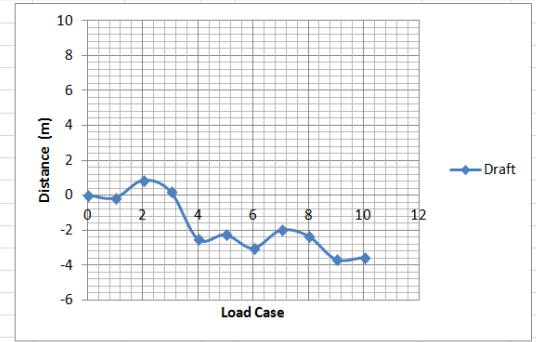

Loading Case 11			Speed 1.50 m/min												
Tank #	on/off	Out/In	Pump Cap. Per Tank (m <sup>3</sup> /s)	Water Pumped (m <sup>3</sup> )	Water in tank (m <sup>3</sup> )	Remaining water in tank (m <sup>3</sup> )	Upright moment (t.m)	t.m/min	Tank state						
1	1	2550	0.14	204.00	53.90	257.90	-13,773.77	-573.91	-38.10	Transfer moment	0.00	t.m	Transfer moment	-7110.6667	t.m/min
3	1		0.14	204.00	140.25	344.25	-3,894.16	-162.26	18.55	Righting moment	-1,340.79	t.m	Δ Transfer moment	100.73	t.m/min
9,10	1		0.28	408.00	1,239.28	1,647.28	-25,961.04	-1,081.71	-148.72	Δ Trim	-1.23	cm	Total trim	-2.72	cm
17	1		0.14	204.00	765.44	969.44	-12,980.52	-540.86	-131.56	Δ draft	0.11	cm	Total draft	-3.46	cm
2	1	2550	0.14	204.00	53.90	257.90	-13,773.77	-573.91	-38.10	Time	24.00	min	Total time	130.21	min
4	1		0.14	204.00	184.75	388.75	-3,894.16	-162.26	18.45						
11,12	1		0.28	408.00	1,284.36	1,692.36	-8,653.68	-360.57	-103.64						
18	1		0.14	204.00	860.50	1,064.50	-4,326.84	-180.29	-36.50						
5	1	-2550	-0.14	-204.00	530.00	326.00	-3,533.59	-147.23	30.00						
7	1		-0.14	-204.00	640.69	436.69	-13,413.20	-558.88	97.09						
13,14	1		-0.28	-408.00	2,222.57	1,814.57	-8,653.68	-360.57	18.57						
19	1		-0.14	-204.00	1,390.14	1,186.14	-4,326.84	-180.29	85.14						
6	1	-2550	-0.14	-204.00	570.50	366.50	-3,533.59	-147.23	30.50						
8	1		-0.14	-204.00	640.69	436.69	-13,413.20	-558.88	97.09						
15,16	1		-0.28	-408.00	2,490.59	2,082.59	-25,961.04	-1,081.71	211.39						
20	1		-0.14	-204.00	1,578.46	1,374.46	-12,980.52	-540.86	227.96						
Σ water tons				0.00			Σ t.m/min (pump)	-7,211.40							

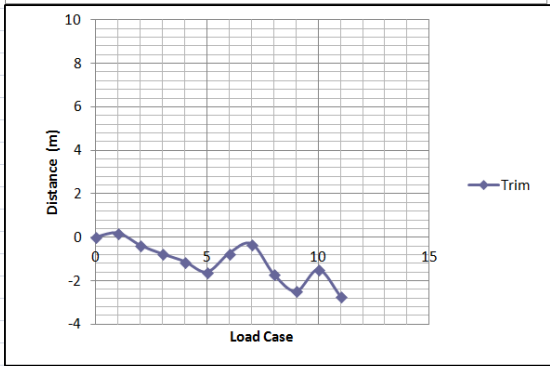
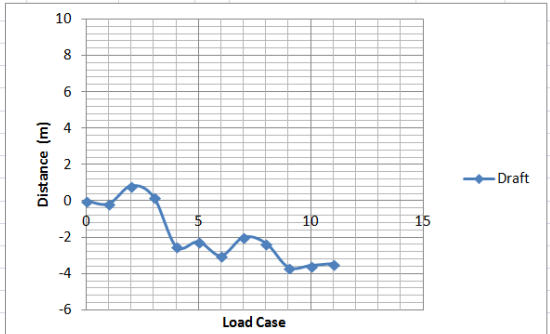
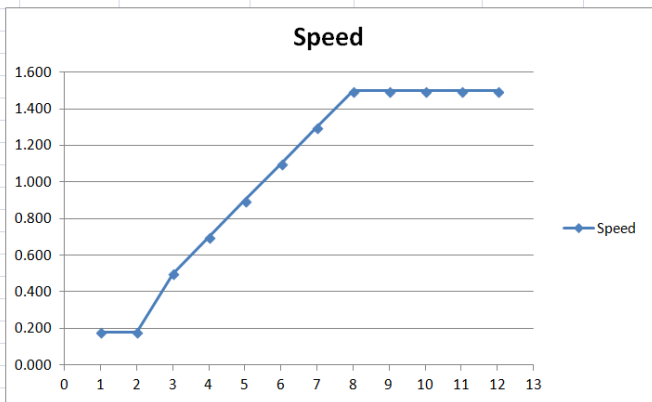
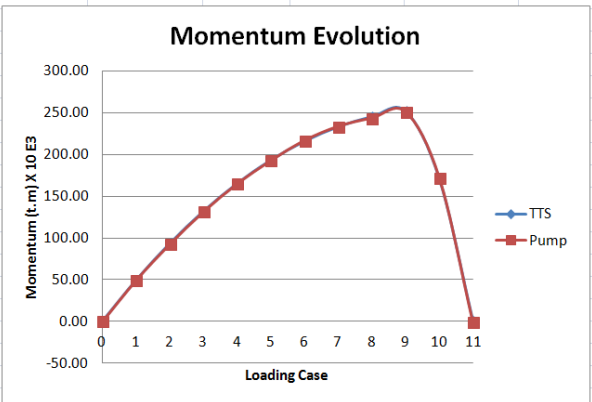

## 8 Bibliography

- [1] *International Maritime Dictionary*. D. Van Nostrand Company, Inc., second edition, 1961.
- [2] Rizwan Butt. *Introduction to Applied Linear Algebra with Matlab*. Heldermann Verlag, 2008.
- [3] Gilles Cazelais. *The Trapezoid Rule*, Accessed: 4 December 2012. [http://pages.pacificcoast.net/~cazelais/187/trapezoidal\\_rule.pdf](http://pages.pacificcoast.net/~cazelais/187/trapezoidal_rule.pdf).
- [4] Anil Bikas Chaudhuri. *The art of Programming Through Flowcharts & Algorithms*. Firewall Media, 2005.
- [5] Shanghai Rongde Engineering Equipment Co. *Floating Dock Central Console*.
- [6] Lewis P. Felton and Richard B. Nelson. *Matrix Structural Analysis*. John Wiley & Sons, Inc., 1997.
- [7] Benny Lautrup. *Bouyancy and Stability*, Accessed: 5 December 2010. <http://www.cns.gatech.edu/~predrag/courses/PHYS-4421-10/Lautrup/buoyancy.pdf>.
- [8] Abramowitz M. and Stegun I.A., editors. *Handbook of Mathematical Functions with Formulas, Graphs, and Mathematical Tables*. DOVER PUBLICATIONS, 1972.
- [9] A.P.I. Marine. *TSS/Docking - Floating Dock Monitoring and Control System*, Accessed: 1 December 2012. <http://www.api-marine.com/tss-docking.aspx>.
- [10] Alfio Quarteroni and Fausto Saleri. *Scientific computing with MATLAB*. Springer, 2003.
- [11] Herbert Sigloch. *Technische Fluidmechanik*. Springer, 2007.
- [12] George P. Tinsker, editor. *Port Engineering*. John Wiley & Sons, Inc., 2004.